

Magdalena Klonowska,  
Krzysztof Kowalski

Department for Knitting Technology  
and Structure of Knitted Fabrics  
Faculty of Textile Engineering and Marketing  
Technical University of Łódź  
ul. Żeromskiego, 90-543 Łódź, Poland  
E-mail: kjkowalski@p.lodz.pl

# Optimising Knitting Process Conditions on the Basis of Controlled Robbing-Back of Yarn

## Abstract

We carried out identification of knitting process conditions during the controlled robbing-back of yarn in the knitting zone of weft-circular knitting machines on the basis of a computer model of the knitting process. The investigations were carried out for needle-raising cams with limited raising height, by negative feeding in the knitting zone, for the classical and Relanit-type knitting techniques. We verified the experimental research results concerned with yarn tensions in the knitting zone and with the sensitivity of the knitted-in yarn's length on the input tension changes with the use of a computer weft-circular knitting machine which was specially designed and built for measuring weft-circular knitting machine). The research results indicate that the knitting process could be realised under conditions of controlled robbing-back of yarns in the knitting zone. Controlled robbing-back enabled the knitting process to be optimised, considering the minimum yarn tension in the knitting zone and the minimum sensitivity of the length of the knitting-in yarn on the changes in the knitting process' technological parameters. The constructional parameters of the optimum cam contours for the classical knitting zone and the Relanit-type knitting zone were defined. These parameters are especially important when manufacturing full-fashion products, considering the dimension stability which they require.

**Key words:** weft knitting machine, knitting process, knitting zone, robbing-back, dynamic tension of yarns.

detail, we can specify three distinctive kinds of robbing-back: the continuous, the discontinuous, and the controlled robbing-back. The latter is characterised by the existence of a yarn reserve in the descending needles' zone after the cycle of loop forming, as the result of continuous yarn release by the raising needles in the direction of the descending needles. The effect of this situation is that the forces in the yarns of the knitting zone achieve minimum values. Under conditions of discontinuous robbing-back, a re-pulling of yarn from the package to the descending needle appears at the end of the loop-forming cycle. The cause of the discontinuity of the robbing-back

phenomenon is that the yarn reserve runs out on the needle which was raised and is positioned behind the point of maximum descending depth. This results in a significant increase in the forces generated in yarns in the knitting zone. Furthermore, in this case, the yarn tension in the knitting zone is about twice as high than during continuous robbing-back [3]. Controlled robbing-back takes place on the boundary between the continuous and the discontinuous robbing-back. A characteristic feature of this phenomenon is that at the end of the loop forming cycle, the yarn reserve in the zone of the raising needles approach or are equal to zero. However, the yarn tensions in the knit-

## Introduction

Robbing back is a fundamental phenomenon which occurs in the knitting zone. It is based on pulling yarns from the knitted loops suspended on needles which are raised up to the loops formed on the descending needles. A description of continuous robbing-back, considering the static aspect, was presented in the works of Knapton & Munden [1], and Lawson [2]. While analysing this phenomenon in

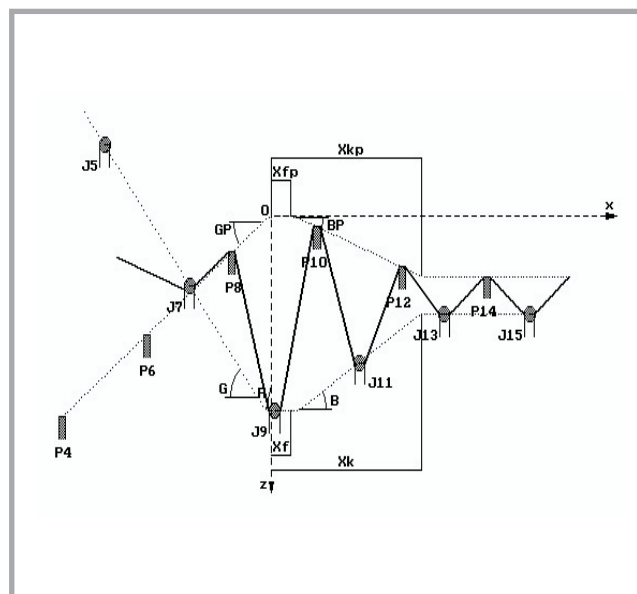

**Figure 1.** Geometrical model of the knitting zone for weft knitting machines;  $x_k$  – horizontal co-ordinate of the needle raising point,  $x_f$  – length of the element guiding the needle in the knitting zone,  $x_{kp}$  – horizontal co-ordinate of the sinker raising point,  $x_{fp}$  – length of the element guiding the sinkers in the knitting zone,  $G$  – descending angle of the needles,  $GP$  – ascending angle of the needles,  $B$  – ascending angle of the needles,  $BP$  – descending angle of the sinkers,  $z$  – descending depth.

ting zone obtain values at the minimum level, similar to those acting in the zone of continuous robbing-back.

The contours of the raising cams in the knitting zone significantly determine the occurrence and the scale of the robbing-back phenomenon. The advantage of this phenomenon is that it causes the generation of relatively low force values in yarns during the knitting process. One disadvantage is that during negative feeding, a great sensitivity occurs of the knitted-in yarn's length to the changes in the knitting process' technological parameters, especially on the input yarn tension. When manufacturing full-fashion products, it is very important to ensure a minimal influence of the knitting process' parameters on the knitted-in yarn's length, considering the stability required for these products. In enterprises which manufacture full-fashion products and where weft-circular knitting machines work, the producers use cams of contours which eliminate the phenomenon of robbing-back. However, on the basis of literature published, it can be stated that this results in maximum yarn tensions occurring in the knitting zone for such contours.

Optimisation of cam contours, carried out in this work, is based on the advantages of the controlled robbing-back (low tensions of the yarns in the knitting zone), while at the same time guaranteeing the minimal influence of the technological parameters on the yarn length in the loop.

## Programme and research methods

Figure 1 presents a geometrical model of the knitting zone, which also takes into consideration the Relanit knitting technique. If the angles GP and BP are equal to zero, then we are dealing with a 'classical' knitting zone.

The objects of our investigation were cams with limited needle raising heights in the knitting zone, and with curvature radii at the dead centres in the knitting zone which equal  $R_t = 0.25$ , as well as with the following values of the descending and raising angles of needles and sinkers (characteristic for the Relanit technique):  $G = 50^\circ$ ,  $B = 30^\circ$ ,  $GP = 35^\circ$ , and  $BP = 19^\circ$ . In this case, the demand for the yarn for one segment suspended on the descending needle is compensated

thanks to the yarn descending back from two segments suspended on the raised needle [4]. This above-mentioned condition is related to the classical knitting technique. While using the Relanit technique, the demand for the yarn is also compensated from the segments suspended on the knocked sinker.

## Simulations of the knitting process

The simulation tests were carried out on the basis of the knitting process' computer model, as presented in Figure 2 and described in work [4], and their scope broadened by the possibility of modelling at positive yarn feeding. The simulations were carried out for constant values of input tensions  $F_0 = 10$  cN, take-up force  $F_A = 3$  cN, needle spacing  $t = 1.81$  mm, lengths of the guiding element  $x_F = 0.4$  mm and  $x_{Fp} = 0.4$  mm, the horizontal co-ordinate of the sinker raising point  $x_{kp} = 0.5t$ , and linear velocity of the cylinder  $v = 1$  m/s. The values of the descending depth  $z$  and the horizontal co-ordinate of the needles' raising point  $x_k$  were changed within such a range that the spacing knitting-in coefficient  $W_t = l/t$  (where  $l$  – is the yarn length in the loop) was to fall within the range  $W_t = 2.0 - 4.2$ . The research results are related to cotton yarn with 20 tex.

The main axis of calculating the time-dependent courses of the forces in yarns and the length of the knitted-in yarn is considering the balance conditions of the knitted-in yarn at the particular friction barriers after the cylinder's displacement by the value  $\Delta x$ . Under these conditions, we calculated the demand of lengths for the yarn in the zone of the knocked needles and the yarn reserve in the range of the raised needles. The geometrical balance of the lengths mentioned above, throughout the range of the yarn's reverse motion, forms the basis for calculating the knitted-in yarn length.

In Figure 3e, the knitting scheme is shown, whereas the dependencies of forces in yarns as a function of time are shown in Figure 3a and 3b. The dependency in Figure 3a is related to the force values in yarns  $F_i$  at the right side of the sinker, i.e. for the odd yarn segments, whereas in Figure 3b the dependency is related to forces  $F_{i+1}$  in the even segments. The graduation of the  $x$ -axis is related to the cylinder displacement of one needle spacing. The maximum value of the forces in yarns in the knitting zone during the loop forming cycle is printed

over the drawing of the knitting zone (Figure 3e). The theoretical curves of the increase in the value of the spacing knitting-in coefficient  $W_t = l/t$  (Figure 3d) give information about the length of the yarn pulled from the package to the particular yarn segments  $i$  and  $i+1$  suspended on the descending needle. The horizontal segments of the drawing indicate the occurrence of robbing-back,

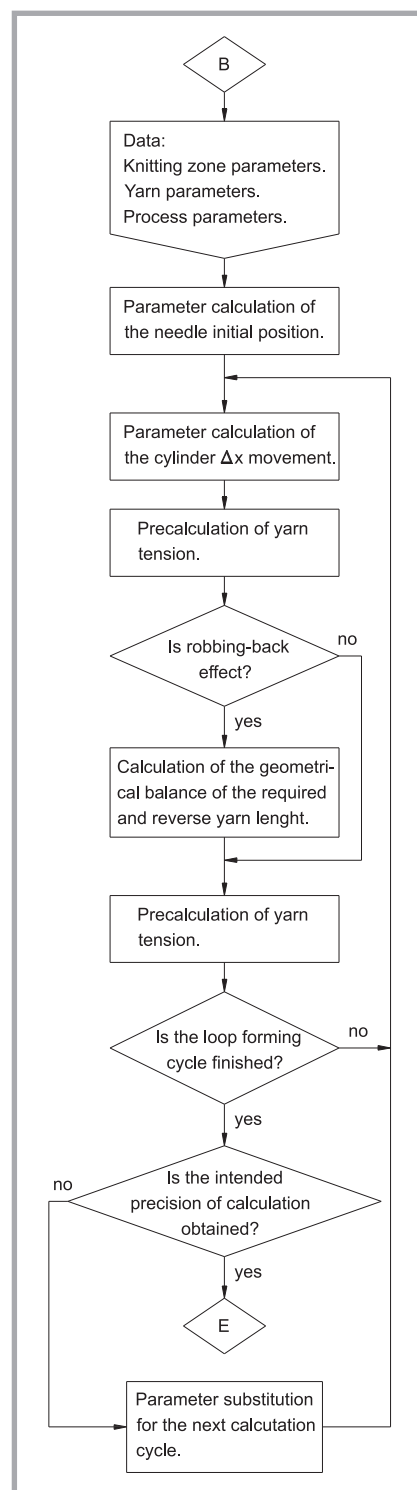
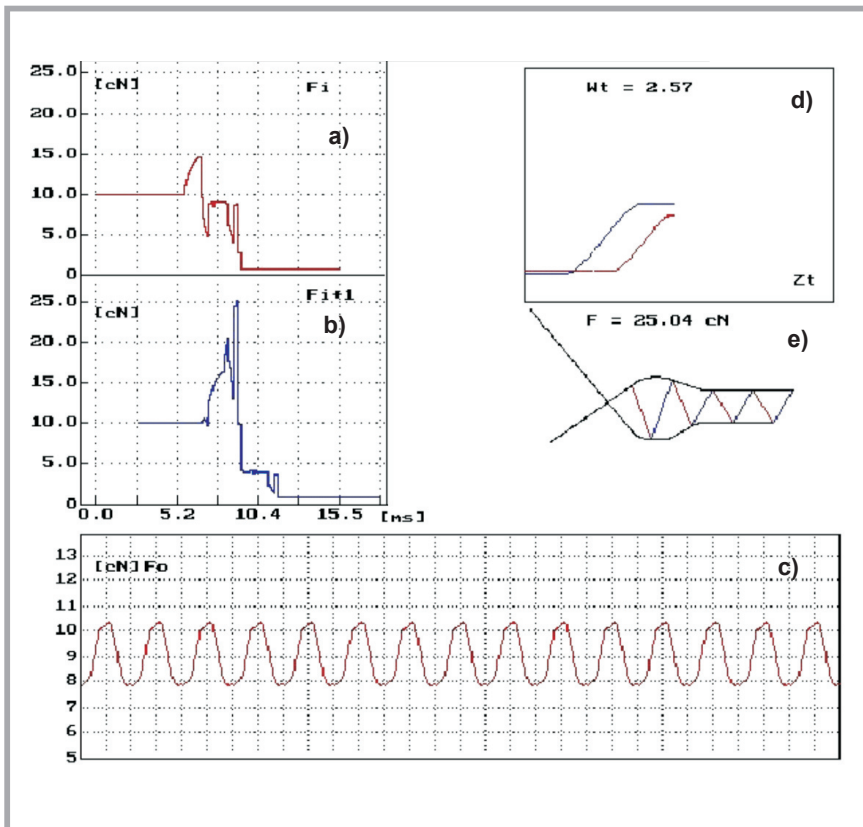
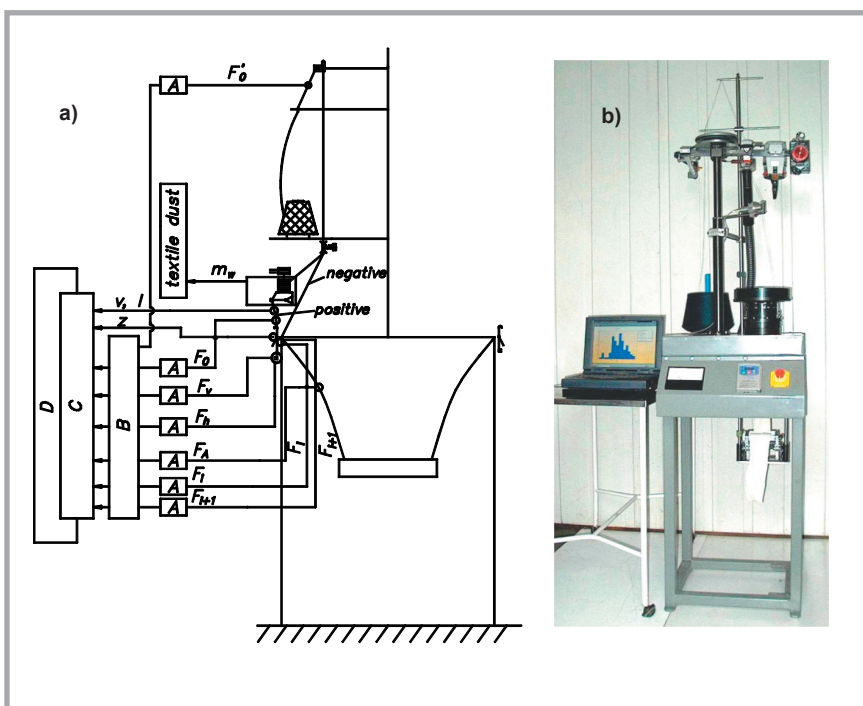

Figure 2. General structure of the algorithm of the knitting process.



**Figure 3.** Results of the digital simulation of the knitting process in the form of curves of dynamic forces in yarns as a function of time, and the curves of increase in the spacing knitting-in coefficient for particular segments of the formed loop; a) dependence of forces in yarns in odd yarn segments ( $F_i$ ) as a function of time, b) dependence of forces in yarns in even yarn segments ( $F_{i+1}$ ) as a function of time, c) dependency of input tension (force)  $F_0$  as a function of time; the period of the  $F_0$  amplitudes is related to the time of a single loop formation marked by the graduation in Figure 3.a and b, d) curves of the theoretical increase in values of the spacing knitting-in coefficient  $W_b$ , e) scheme of the knitting zone with the maximum value of the forces in yarns during the loop forming cycle.



**Figure 4.** Measuring computer weft-circular knitting machine; a) general view; b) brief measuring scheme of the machine, A – force-gauge measuring transducers, B – DC amplifier, C – AD converter (switching frequency 10 MHz), D – PC Pentium.

which totally compensates the yarn demand for the yarn segment which is on the descending needle. The sum of the values of the yarn lengths pulled over from the package to the particular segments at the point of the maximum descending depth in relation to the needle spacing is related to the value of the spacing knitting-in coefficient  $W_b$ , whose value is printed in the upper part of the drawing (Figure 3.d).

### Experimental investigations

The experimental investigations were carried out with the use of a measuring computer linked to a weft-circular knitting machine with a classical knitting zone presented in Figure 4. This knitting machine enables the measurement of dynamic forces in yarns in the knitting zone and the length of the knitted-in yarn [5]. The investigations firstly served to verify the simulation tests of tension the yarns in the knitting zone as well as the influence of the input tension on the yarn length in the loop. The investigations were performed for cam contours, which guarantee the continuous, controlled, and discontinuous robbing-back.

### Analysis of the results of simulation tests

The investigations carried out indicate that it is possible to conduct the knitting process under conditions of controlled robbing-back of the yarn in the knitting zone. On the basis of Figure 5, we can state that in the classical knitting zone, the phenomenon of discontinuous robbing-back occurs if  $x_t < 1$ , continuous robbing-back takes place if  $x_t > 1$ , and controlled robbing-back is observed if  $x_t = 1$ . In the case of the Relanit knitting technique, discontinuous robbing back occurs if  $x_t < 1.25$ , continuous robbing-back if  $x_t > 1.25$ , and controlled robbing-back if  $x_t = 1.25$ .

From Figure 5 we can see that the optimal conditions of the knitting process for a typical cam contour with angle values of  $G = 50^\circ$  and  $B = 30^\circ$  appear for the horizontal co-ordinate of the raising needle point  $x_k = 1$  in the case of the classical knitting technique. For the Relanit knitting technique, the optimal knitting conditions take place for  $x_k = 1.25t$  for a cam contour of angles  $G = 50^\circ$ ,  $B = 30^\circ$ ,  $GP = 35^\circ$ , and  $BP = 19^\circ$ . For such values of  $x_k$ , the yarn reserve in the range of the raising needles approach zero. This why

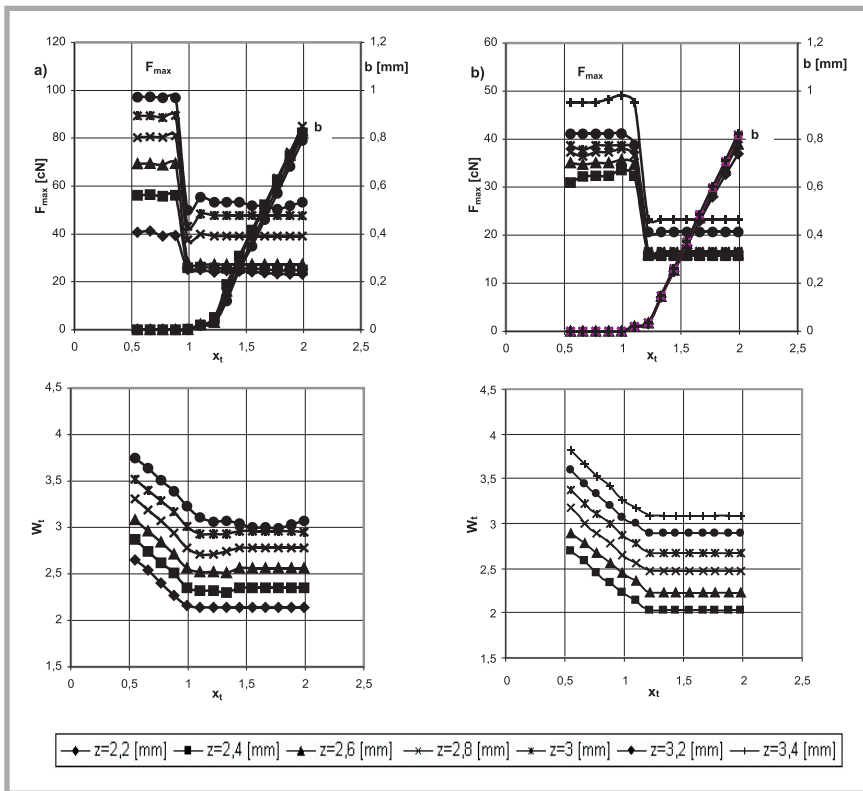

**Figure 5.** Influence of the value of the horizontal co-ordinate of the raising needle point  $x_t$  ( $x_t = x_k/t$ ) and the descending depth  $z$  on the value of the maximum force in the yarns  $F_{max}$ , the value of spacing knitting-in coefficient  $W_t$ , and the value the yarn reserve  $b$  in the range of the needles raised; a) classical knitting technique, b) Relanit knitting technique.

minimum sensitivity occurs in the length of knitted-in yarn to the changes in the technological parameters of the knitting process, whereas the yarn tensions in the knitting zone are at the level of minimum values, such as occur in the zone of continuous robbing-back.

## Experimental verification of the research results

### Investigation of yarn tensions in the knitting zone

The experimental investigations of yarn tension in the knitting zone (Figure 6)

fully confirm the results obtained in simulation tests carried out for selected cam contours on the weft-circular knitting machine with the classical knitting zone. For the horizontal co-ordinate of the raising needle point  $x_k = t$ , the force values in treads in the knitting zone are relatively low, and are related to those of the zone of continuous robbing-back.

### Investigations of the sensitivity of the length of the knitted-in yarn to the changes of input tension

The investigations carried out enabled us to determine the length's sensitivity of the knitted-in yarn to the changes of input tension, which is especially important when manufacturing full-fashion products, considering the dimensional stability which they require.

From Figure 7 we see that, under the condition of continuous robbing-back and by negative feeding, a great sensitivity exists of the length of the knitted-in yarn to the changes in the input yarn tension. Under these conditions, a greater intensity of the input tension exists for lower tension values. From the simulation investigations, as well as the experimental tests carried out, it results that during controlled robbing-back (if  $x_k = 1$ ) the influence of the input tension on the yarn length in the loop is relatively small.

## Conclusions

The investigations carried out indicate that it is possible to conduct the knitting

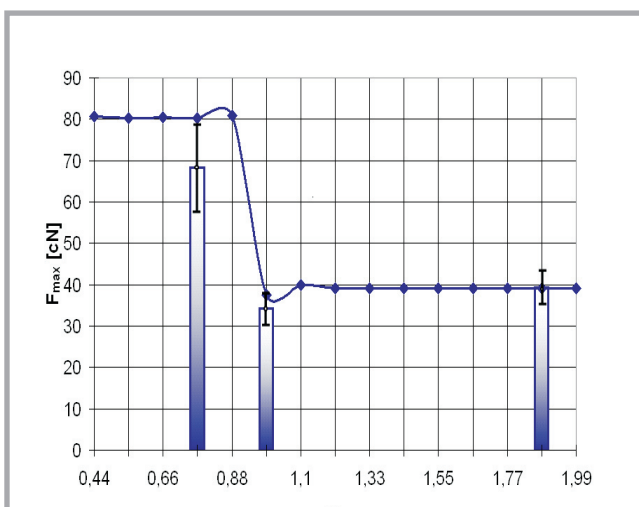

**Figure 6.** Calculated maximum force values ( $\diamond$  - calculated points and solid line) and measured maximum force values (columns with marked measurement dispersions) in the yarns in the knitting zone, in cN, in dependence on the values of the horizontal co-ordinate  $x_t$  of the point at which the needles are raised; knitting process parameters: input tension  $F_0 = 10$  cN, take-up force  $F_A = 3$  cN, descending depth  $z = 2.26$  mm.

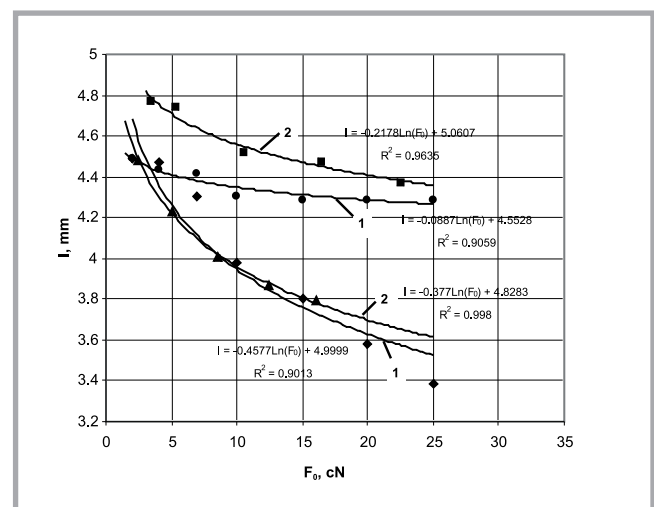

**Figure 7.** Influence of the input tension on the yarn length in the loop (for the classical knitting zone); parameters of the knitting process: input tension  $F_0 = 10$  cN, take-up force  $F_A = 3$  cN, descending depth  $z = 2.4$  mm; 1 - simulation curve, 2 - experimental curve;  $\diamond$  -  $x_k = 2.8$  t,  $\blacktriangle$  -  $x_k = 2.8$  t,  $\blacksquare$  -  $x_k = 1$  t,  $\bullet$  -  $x_k = 1$  t

process under conditions of controlled robbing-back of yarn. Simulations and experimental investigations fully confirm the proposition that controlled robbing-back ensures low yarn tensions in the knitting zone as well as low sensitivity of the length of the knitted-in yarn to the changes in the technological parameters of the knitting process. The advantages of controlled robbing-back become apparent especially for knitted fabric assortments which are manufactured at negative yarn feeding. On the basis of the advantages of controlled robbing-back, the optimum construction parameters of the cam contours were defined for selected values of the descending and raising angles for the classical and Relanit knitting zones. The model of the knitting process elaborated in the numerical version enables optimum conditions to be defined for the knitting process during controlled yarn robbing-back for the needles' descending and raising angle values other than those discussed in this article.



### Acknowledgment

*This investigation was carried out as part of the supervisor's project No. 3T08E 085 26, sponsored by the Polish Ministry of Science and Information Technology.*

### References

1. Knapton I. F., Munden D. L., 'A Study of the Mechanism of Loop Formation on Weft-Knitting Machinery', *Textile Research Journal*, 12, 1966, pp.1072-1091.
2. Lawson I., 'The Art of Knitting', *Knitted Outerwear Times*, New York, 6, 1969, pp. 42-45.
3. Klonowska M., Kowalski K., 'Assessment of Knitting Conditions at States of Discontinuous Robbing Back in the Knitting Zone on Weft-Knitting Machines', *Fibres & Textiles in Eastern Europe*, vol. 10, No. 3 (38), 2002, pp. 50-52.
4. Kowalski K., 'Identification of the dynamic forces in yarns on weft knitting machines on the basis of computer simulation and digital measuring technique (in Polish)', *Zeszyty Naukowe (Scientific Letters) No. 613, Scientific dissertations No. 147, Technical University of Łódź*, 1991.
5. Kowalski K., Kapusta H., 'Integrated method of estimation of the knitting process and the yarn (in Polish)', *Report of research project No. 7 T08E 01916 of the Polish State Committee for Scientific Research, Łódź*, 2001.

 Received 18.05.2005 Reviewed 19.09.2005

## Next XIPS

The 7<sup>th</sup> in series meeting  
on the

# X - Ray Investigation of Polymer Structure XIPS' 2007

is scheduled for the the second half of 2007

For further information please contact:

**Prof. Andrzej Włochowicz Ph. D., D. Sc.**

UNIVERSITY OF BIELSKO-BIAŁA  
Faculty of Textile Engineering  
and Environmental Protection  
Institute of Textile Engineering and Polymer Materials  
ul. Willowa 2, 43-309 Bielsko-Biała  
tel. +48 33 8279 114, fax. +48 33 8279 100  
e-mail: awlochowicz@ath.bielsko.pl

or

**Prof. Janicki Jarosław Ph. D., D. Sc.**

UNIVERSITY OF BIELSKO-BIAŁA  
Faculty of Textile Engineering  
and Environmental Protection  
Institute of Textile Engineering and Polymer Materials  
ul. Willowa 2, 43-309 Bielsko-Biała  
tel. +48 33 8279 114, fax. +48 33 8279 100  
e-mail: jjanicki@ath.bielsko.pl

