

Juanfeng Jin,  
Yunchu Yang,  
Fengyuan Zou

# Developing an Intelligent Model for the Construction a Hip Shape Recognition System Based on 3D Body Measurement

DOI: 10.5604/12303666.1215535

Fashion Institute,  
Zhejiang Sci-Tech University  
(Zhejiang Provincial Research Center  
of Clothing Engineering Technology),  
Hangzhou, 310018, P. R. China  
E-mail: jif6859@163.com

## Abstract

*The purpose of this paper was to develop an intelligent recognition system consisting of a feature reduction method combining cluster and correlation analyses, and a probabilistic neural network (PNN) classifier to identify different types of hip shape from 3D measurement for each person. Firstly 28 items reflecting lower body part information of 300 female university students aging from 20 to 24 years were selected. The feature reduction method was employed to extract typical indices. Secondly hip shapes were subdivided into five types by a K-means cluster and analysis of variance (ANOVA). Finally the PNN was then trained to serve as a classifier for identifying five different hip shape types. The average classification accuracy of the scheme proposed was 97.37%, and its effectiveness was successfully validated by comparing with the BP and Support Vector Machine (SVM) scheme. Thus an intelligent recognition system was developed to make hip shape type classification of high-precision and time saving.*

**Key words:** intelligent recognition system, probabilistic neural network, classification accuracy, feature reduction, typical index, cluster analysis.

## Introduction

It is fundamental for producing high quality garments in the apparel industry to measure body shapes and clarify their statistical features. The development of a body shape classification scheme plays an important role in meeting the clothing fit. Body shape classifications were carried out with anthropometric data by the 3D body measurement technique [1], and considered in various categories from lateral [2] and frontal shapes of the body [3]. However, a limited amount of studies have been noted regarding the integration of body scanning for the use of a partial shape [4] for certain populations [5] in the apparel industry, especially for the position which affects clothing fit greatly, such as the hip part.

Body shape is an important classification issue. There are several popular methods used for classifying body shape types, which can be categorized as follows: the Visual Assessment Method, Statistical

Analysis of Measurements Method and Artificial Intelligence Method. Among these, the Visual Assessment Method and Statistical Analysis of Measurements Method are used for classification, but their shortcomings have been identified, causing the Artificial Intelligence Method to have advantages of application in classifying analysis. Among the deficiencies identified in the Visual Assessment Method is its objectivity, which is difficult to guarantee because this method depends solely on subjective evaluation [6, 7]. Meanwhile the Statistical Analysis of Measurements Method has been found to have a lack of accuracy and be not flexible [8, 9]. For classification analysis, Artificial Intelligence Methods such as the Artificial Neural Network (ANN), Support Vector Machine (SVM) and Probabilistic Neural Network (PNN) are widely applied due to their good accuracy result and the ability of analysing nonlinear problems which are difficult to solve by classical methods [10].

Recently intelligent systems have been widely utilised as classifiers for pattern recognition [11, 12], especially neural networks that have already been treated as a powerful classifier to deal with pattern design [13, 14] and body shape classification problems [15]. Zou et al established a model of an artificial neural network with a BP Network algorithm to identify the body type of young women aged 15 - 35 in terms of the experience of fashion designers, and an overall identification accuracy of 82.6% was achieved

[16]. However, the BP algorithm suffers from a slow convergence rate and often yields suboptimal solutions [17]. Zhang et al developed a SVM model to identify young women's body shapes taking 32 seconds for training 200 samples and 2 seconds for testing 50 samples, and the average accuracy achieved was 92.5% [18], but SVM can be abysmally slow in the test phase, although it has good generalisation performance [19]. Better than the above two methods, the PNN can provide a general solution to pattern classification problems by Bayesian classifiers. Its main advantages are the fast training process. An inherently parallel structure guaranteed to converge to an optimal classifier as the size of the representative training set increases; meanwhile, the training samples can be added or removed without extensive retraining [20]. It has been widely used to solve pattern recognition and classification problems in geotechnical engineering [21], in ocean engineering [22] and in medical diagnosis [23]. Jamal et al developed a hybrid intelligent model for constructing a size recommendation expert system based on data clustering and a PNN to enable the salesperson to help the consumer in choosing the right size, and the accuracy of the system proposed achieved 87.2% [24].

Hence in this paper, we aimed to develop an intelligent hip shape classification system with 3D anthropometric measurements integrating a statistical analysis

method and PNN technique. *Figure 1* gives an overview of the method proposed. To mitigate limitations of classification methods, the method proposed introduced feature parameter variables representing hip shape types. In addition, results of statistical analysis of 3D scan data of female university students were incorporated into the PNN technique to identify the hip shape types.

## Methods

### Data acquisition

#### 3D body scanning

300 female university students of ages ranging from 20 to 24 years were scanned with a [TC]<sup>2</sup> 3D body scanner ([TC]<sup>2</sup> Corporate, USA). During the scanning, each individual wore short tight pants and a swimming cap, in addition to a bra-top. The mean value of three-times-repeated measurements from each individual was chosen in order to reduce the systematic measuring error. The head could not be scanned by the [TC]<sup>2</sup> 3D body scanner, which is only suitable for objects of light colour, the subjects' hair being dark. Measurement of height (H) was performed directly on the subjects using a Martin ruler according to ISO7250, and the measurement of weight (Wei) was done using a weight scale. Gaussian distribution of height (H) and weight (Wei) are described in *Figure 2* and *Figure 3*, respectively.

#### Preprocessing

To exclude abnormal data from the analysis, differences from the range of “the mean difference  $\pm 3\sigma$ ” ( $\sigma$ : SD of differences) were considered as abnormal and excluded from the analysis. As a result, 2.67% of the data were excluded, and the rest, scan data of 292 subjects, were used last. The abnormal difference values were generally a result of recording errors and 3D body scan measure-

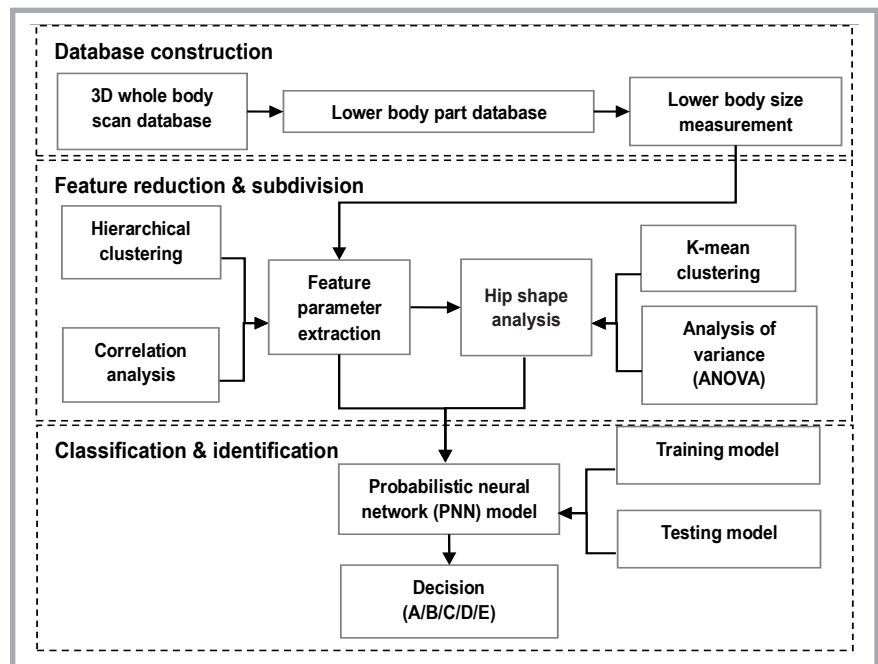

*Figure 1.* Overview of the proposed method.

ment errors due to the poor quality of scan data.

#### Measurements of items

For the major lower part size, a total of 28 items were selected, as listed in *Table 1* and *Figure 4*, respectively. Although the [TC]<sup>2</sup> 3D body measurement scanner provides whole body size measurement for each subject, we decided to take lower part size measurement only as we were making a classification for the type of hip shape. 20 items of body size measurement (marked 1), except the height and weight, were obtained by directly measuring the 3D models using the scanner, and the other size items (marked 2) were obtained by calculation.

#### Feature reduction method

##### Hierarchical clustering of the size items

Cluster analysis methods can classify sets of data samples into clusters according to

similarity. For cluster analysis, the hierarchical cluster method was successfully cited in literature [25]. The hierarchical cluster method is used to build a hierarchy of clusters. According to the similarity between sets of data samples, it can decide which clusters should be combined. By repeating the combination process accumulatively, a hierarchical structure of the samples is determined, and then the data given can be divided into several groups on the basis of certain similarity levels by using such a structure. Hence based on the items shown in *Table 1*, we adopted the hierarchical cluster method [26] with weighted average linkage and the squared Euclidean distance to cluster the database in order to obtain a better analysis result.

##### Correlation analysis for typical indices

To classify the distributional tendencies of the hip shapes, we first adopted

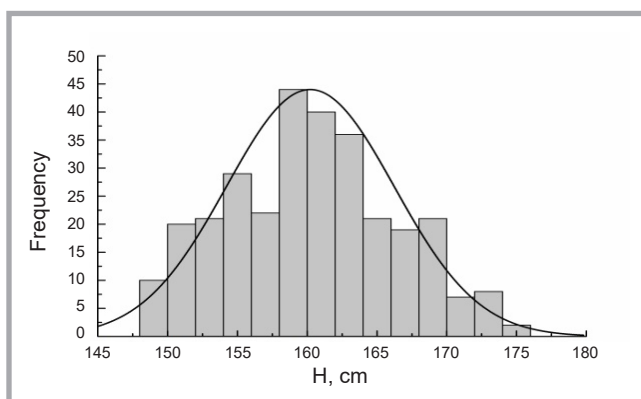

*Figure 2.* Gaussian distribution of H.

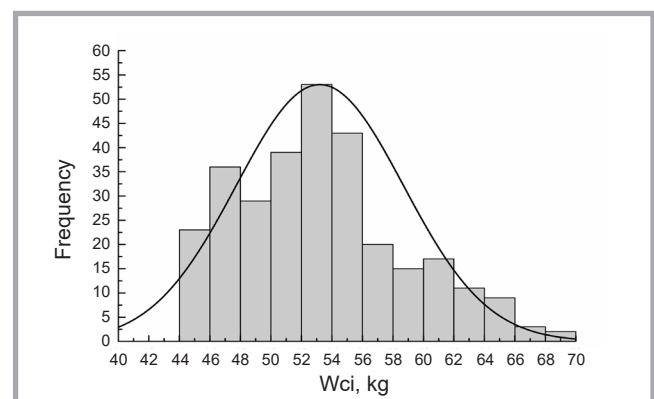

*Figure 3.* Gaussian distribution of Wei.

**Table 1.** Body size items to be measured **Note:** items (marked 1) mean the data were obtained by directly measuring the 3D models using the scanner; and items (marked 2) were obtained by calculation.

No.	Items	Definition	No.	Items	Definition
1	H	Height	15	AbH 1	Height of abdomen
2	Wei	Weight	16	AbT 1	Thickness of abdomen
3	WG 1	Girth of waist	17	AbW 1	Width of abdomen
4	HG 1	Girth of hip	18	AbW/AbT 2	Width of abdomen divided by thickness of abdomen
5	FHG 1	Front part of HG	19	VRL 2	VRise length
6	BHG 1	Back part of HG	20	CrH 1	Height of crotch
7	HH 1	Height of hip	21	CrL 1	Crotch length
8	HT 2	Thickness of hip	22	FCrL 1	Front part of crotch length
9	HW 1	Width of hip	23	BCrL 1	Back part of crotch length
10	SBA 1	Seat back angle	24	WHL 1	Length of waist to hip
11	HW/HT 2	Width of hip divide thickness of hip	25	OuL 1	Length of outseam
12	AbG 1	Girth of abdomen	26	InL 1	Length of inseam
13	FAbG 1	Front part of AbG	27	AbF_X-HB_X 2	Abdomen_front X minus Hip_back X, named thickness of abdomen-hip
14	BAbG 1	Back part of AbG	28	AbB_X-HB_X 2	Abdomen_back X minus Hip_back X, named hip convex

the data samples of 28 variables provided by the lower body part database. However, using all the variables causes deficiency in classification. Therefore we did a variables reduction before classifying hip shapes. For this reason, we applied correlation analysis to obtain the correlation coefficient between variables and introduced a typical index algorithm to extract the feature parameter using the following steps:

1. calculate the correlation coefficient matrix  $R$  in the case where there are  $N$  indices, namely  $a_1, a_2, \dots, a_n$  in one

$$\text{group, } R = \begin{bmatrix} r_{11} & r_{12} & \dots & r_{1n} \\ r_{21} & r_{22} & \dots & r_{2n} \\ \vdots & \vdots & \vdots & \vdots \\ r_{n1} & r_{n2} & \dots & r_{nn} \end{bmatrix};$$

2. calculate the value of  $\overline{r_i^2}$  with following formula:

$$\overline{r_i^2} = (\sum_{j=1}^n r_{ij}^2 - 1) / (n_i - 1) \quad i = 1, 2, \dots, n \quad (1)$$

where,  $r_{ij}$  is the correlation coefficient, and  $n_i$  is the amount of indices of the  $i$  category.

3. compare the value of  $\overline{r_i^2}$

If  $\overline{r_k^2} = \max_{1 \leq i \leq n} \overline{r_i^2}$ , then  $a_k$  can be extracted as the typical index of  $a_1, a_2, \dots, a_n$ .

Thus in the typical index the amount of original variables can be reduced to a few latent variables that still represent the main information of the original sets of data samples.

### Subdivision of young female hip shapes

The K-means cluster is a method of vector quantisation, originally from signal processing, that is popular for cluster analysis in data mining. Given a set of observations  $x_1, x_2, \dots, x_n$  where each observation is a  $d$ -dimensional real vector; k-means clustering aims to partition the  $n$  observations into  $k$  sets ( $k \leq n$ )  $S = \{S_1, S_2, \dots, S_k\}$  so as to minimise the within-cluster sum of squares (WCSS):

$$\text{argmin} \sum_{i=1}^k \sum_{x_j \in S_i} \|x_j - \mu_i\|^2 \quad (2)$$

where,  $\mu_i$  is the mean of points in  $S_i$ .

The K-means cluster directly decomposes the dataset into a set of disjoint clusters and attempts to determine the desired partitions that optimise a certain criterion function (similarity measure). It can produce the optimal result even for very large data sets with respect to a defined criterion, namely the input parameter of the cluster number and defined similarity measure. It is suitable for very large data sets.

Hence we adopted the k-means cluster to subdivide the hip shapes based on typical indices. It was noted that the result of k-means clustering can be diverse for the same data set with different cluster numbers [27]; thus we chose the cluster number based on the analysis of variance (ANOVA) of each cluster.

### Probabilistic neural network classifier

A probabilistic neural network (PNN) is a basic pattern classifier which is developed from the combination of the Bayes decision strategy and Parzen non-parametric estimator of the probability density functions (PDF) of different classes [28]. Because of its easy implementation with a probabilistic output and application to problems containing any number of classes, the PNN has been widely used to solve the problem of pattern recognition. A PNN can be realised as a network of four layers: an input layer, pattern

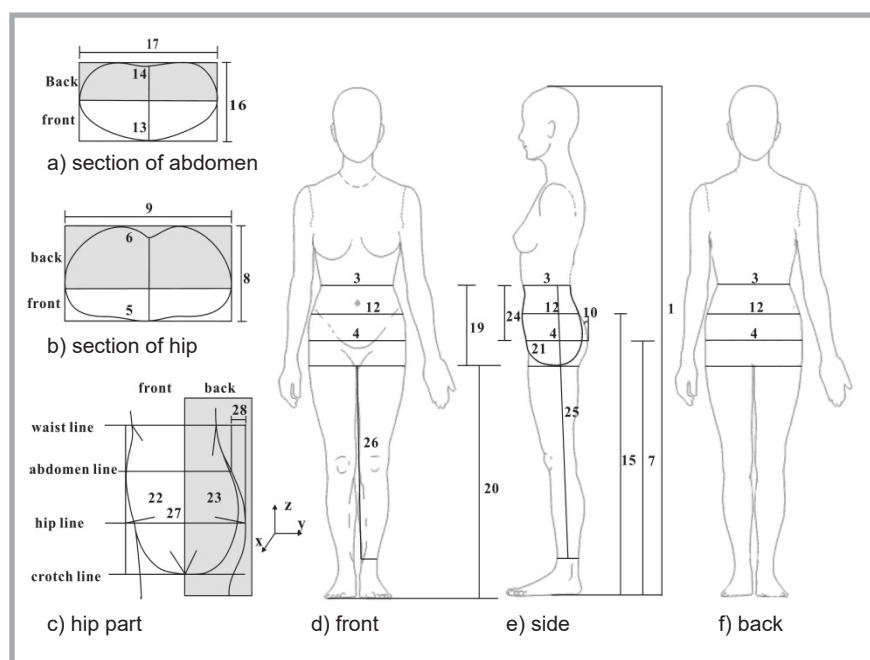

**Figure 4.** Description of items.

layer, summation layer and output layer, shown in **Figure 5**.

The input layer consists of  $r$  input nodes, passing the inputs to the next layer. In **Figure 5**,  $j, k, l, m$  and  $n$  are the numbers of Type 1 (A), Type 2 (B), Type 3 (C), Type 4(D) and Type 5 (E) training vectors, respectively.

The pattern layer estimates the probability density function (PDF) of the input vector  $X$  by the Parzen window method. In this study, we chose the Gaussian function as the Parzen window for its uniqueness of representation of data with normal distribution. In this layer, the Euclidean distance between the input vector  $X$  and training vector  $T$ , is calculated for its description of the closeness between the input and training vectors; in addition, the Euclidean distance is used as the argument of the Gaussian function to compute the PDF. Therefore the neurons of the pattern layer,  $A_{ip}$ , with the  $i$ th neuron belonging to the  $p$ th class, are represented as follows:

$$A_{ip} = \frac{1}{(2\pi)^{r/2} \sigma^r} \exp\left[-\frac{\|X - T_{ip}\|^2}{2\sigma^2}\right] \quad (3)$$

where,  $T_{ip}$  is the  $i$ th training vector belonging to the  $p$ th class, and  $\sigma$  is the smoothing parameter. In **Figure 5**,  $p$  is denoted by subscripts “A” for Type 1, “B” for Type 2, “C” for Type 3, “D” for Type 4 and “E” for Type 5.

In the summation layer, the Bayesian likelihood ratio is calculated by the PDF from the pattern layer, and then the input was classified based the ratio. Thus the summation of  $A_{ip}$ ,  $A_p$  is made as follows:

$$A_p = \frac{1}{(2\pi)^{r/2} \sigma^r} \sum_{i=1}^{i=N} \exp\left[-\frac{\|X - T_{ip}\|^2}{2\sigma^2}\right] \quad (4)$$

where,  $N = j$  in Type 1,  $N = k$  in Type 2,  $N = l$  in Type 3,  $N = m$  in Type 4,  $N = n$  in Type 5.

In the output layer, the five values from the summation layer are compared to select the maximum one as the output. In **Figure 5** output  $Y$  indicates the specific class the input vector belongs to based on the summation layer output.

In this paper, the application of the PNN model was supported by software called

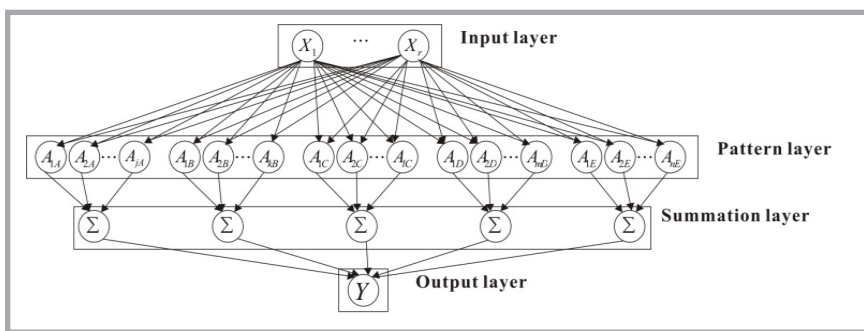

**Figure 5.** Architecture of PNN.

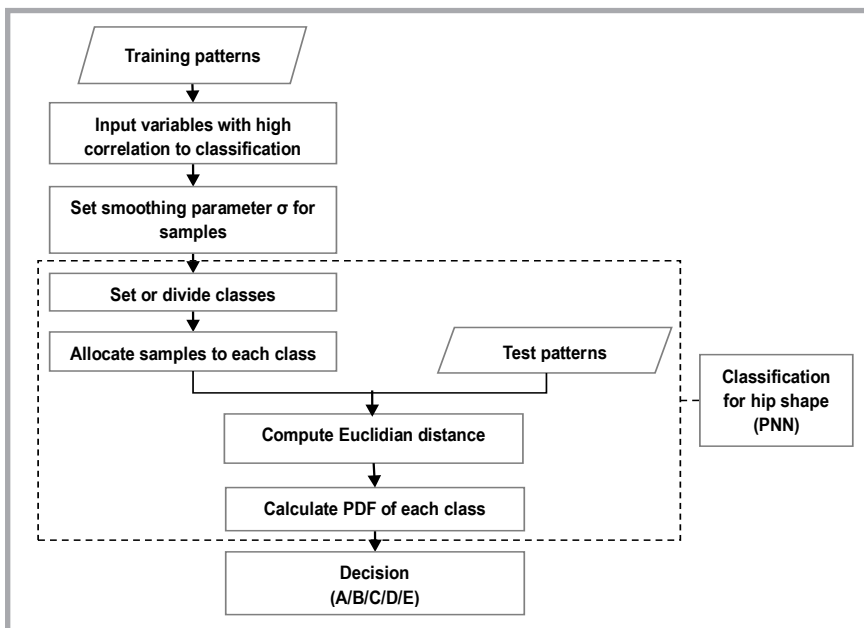

**Figure 6.** Implementation procedures of PNN.

**Table 2.** Specification for selection of each class.

	Class					Total
	Type 1	Type 2	Type 3	Type 4	Type 5	
Recognition type	A	B	C	D	E	
Total of samples	5	43	65	79	100	292
Amount of training patters	3	32	49	59	75	218
Amount of testing patters	2	11	16	20	25	74

MATLAB R2009a (MathWorks Inc., Massachusetts, USA).

**General procedure**

The general implementation procedure of modelling hip shape identification in this paper was summarised in a flowchart, as shown in **Figure 6**. The training patterns were based on 28 data items provided by the 3D body measurement scanner. First the characteristic parameters, typical indices with high correlation to classification, were chosen as the input variables. Then the smoothing parameter  $\sigma$  was selected through user-defined constants. In the succeeding steps, the classification

was performed, with classes set or divided, samples allocated, the Euclidian distance between the training and test pattern computed, and the PDF calculated. Finally the output (class) was obtained through calculating the PDF.

**Training**

In this paper the input parameters were the six typical indices, including  $HH, HG, AbF\_X-HB\_X, AbB\_X-HB\_X, HW/HT$  and  $CrL$ . To give an equal weighting factor before applying the data to the network proposed, all of the input data were normalized to 0.1 - 0.9. The output (class) was the type of hip shape, namely

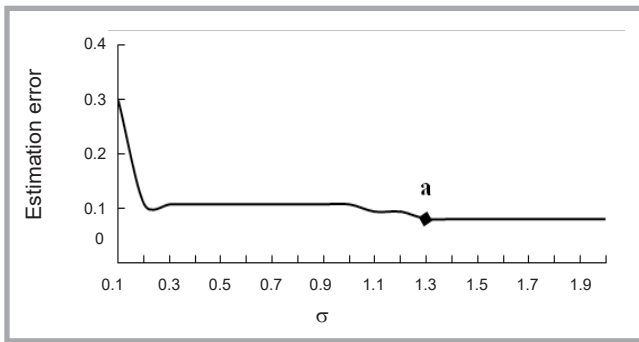

Figure 7. Estimation result of PNN with different  $\sigma$

Types 1, 2, 3, 4 and 5, making a total of five classes.

Classification of the PNN model was trained by randomly dividing the available set of data (292 samples) into a training set and testing set. Three-fourths of the samples selected randomly from a class were used for training patterns, while the rest were used for testing patterns. Thus there were a total of 218 training patterns and 74 testing patterns for classes, with the specification for selection of each class is listed in Table 2.

#### Smoothing parameter ( $\sigma$ )

In this paper we chose the value of smoothing parameter  $\sigma$  in a ranging from 0.1 to 2 and determined the optimal one that better evaluates the distribution of

test results. Figure 7 shows the estimation result of the PNN for all test patterns using the above values of  $\sigma$ . It was obvious that the value of smoothing parameter  $\sigma$  had a great effect on the estimation error in the PNN, and that the estimation error had been reduced until  $\sigma = 1.3$  (marked a); hence smoothing parameter  $\sigma = 1.3$  provided the smallest estimation error. Thus smoothing parameter  $\sigma = 1.3$  was finally adopted for the PNN in this paper.

## Results and discussions

### Feature dimension reduction

In this paper the hierarchical cluster method was applied to classify the twenty-eight items mentioned above into sev-

eral bigger groups formed by merging items based on 3D body scanning data. Moreover the process result of hierarchical clustering was illustrated in a graphic called a dendrogram, as shown in Figure 8 (dotted line rectangles denote the groups divided on the basis of the clustering results), which allowed a good impression of the similarity between the items. In this dendrogram, the data points appear to cluster six groups, including a different number of items. Both the fourth and fifth clusters contain two items respectively, whereas the second cluster contains nine items. In contrast, the first, third and sixth cluster included six, four and five samples, respectively.

Then we established the extract feature parameter through a typical index algorithm based on the correlation coefficient obtained by correlation analysis following the steps mentioned above, and calculated the values of  $r^2$  in each variable listed in Figure 9.

Thus the twenty-eight original variables were directly reduced to a few latent variables, six typical indices named *HH*, *HG*, *AbF\_X-HB\_X*, *AbB\_X-HB\_X*, *HW/HT* and *CrL*, that could still represent the main information of the original sets of data samples.

### Subdivision of hip shape types

The hip shape database was firstly partitioned using a k-means cluster, with the cluster number ranging from 3 to 5 according to the six typical indices so as to obtain the optimal cluster number based on analysis of variance (ANOVA). ANOVA could measure the overall variances between the groups as well as the overall variances within the groups. By ANOVA, cluster number distribution and clustering results are shown in Table 3. It was apparent that based on the probability ( $P$ ) value, the cluster numbers desired could be easily identified, and we concluded that 5 was the cluster number desired for the hip shape database. From Table 3 with five cluster numbers, it could also be realized that the Cluster Mean Square (CMS) between groups of any variable from six typical indices was so much larger than the Error Mean Square (EMS) within groups. From the  $P$  value, it could be seen that the  $P$  value of each variance was smaller than 0.05, which meant we rejected the null hypothesis and assumed that the probability that the observed group's means would have appeared by chance was less than 5%.

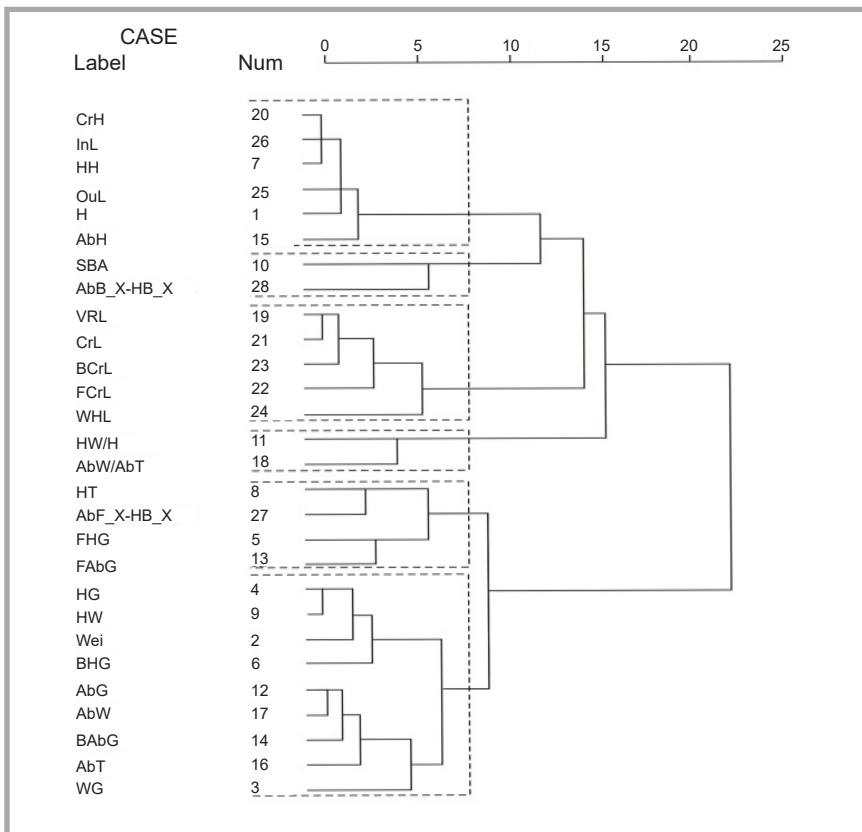

Figure 8. Dendrogram of hierarchical cluster of items

Moreover it was noticed that the null hypothesis tested in ANOVA was equal to the group means. In addition, the result of ANOVA presented that the differences among five groups were great enough to identify each group successfully by the six variances. Thus the optimal number, which was five in this paper, was chosen as the cluster number desired.

Moreover the cluster results of the database displayed in **Table 4** were portioned by direct implementation of k-means clustering. **Table 4** summarised the final cluster centre and capacity of each type for the optimal cluster number based on six typical indices. As shown in **Table 4**, the highest and lowest proportions of samples were 34.3% (100 samples) for Type 5 and 1.7% (5 samples) for Type 1, respectively. Moreover the proportions of Type 2, Type 3 and Type 4 were 14.7% (43 samples), 22.3% (65 samples) and 27% (79 samples), respectively. A body with a similar size to the final cluster centre was treated as the standard body of the cluster. Both the front and lateral hip shape of a standard body, and the curve of its hip section among the clusters were observed in this paper, shown in **Figure 10** (see page 116).

### Comparison of the method proposed with other existing approaches

Classification of the performance of the testing scheme proposed was validated by a total number of 74 testing patterns of five hip shape types, including 2 samples of Type 1 (A), 11 samples of Type 2 (B), 16 samples of Type 3(C), 20 samples of Type 4 (D) and 25 samples of Type 5 (E), listed in **Table 2**. To evaluate the performance of the testing scheme, three common measures of sensitivity (SENS), specificity (SPEC), and accuracy (ACCU) [29] were used, defined as follows:

$$SENS(\%) = \frac{TP}{TP + FN} \times 100 \quad (5)$$

$$SPEC(\%) = \frac{TN}{TN + FP} \times 100 \quad (6)$$

$$ACCU(\%) = \frac{TP + TN}{TP + TN + FP + FN} \times 100 \quad (7)$$

where *TP* was true positive, *FN* false negative, *TN* true negative, and *FP* false positive.

This study presented an application of the PNN with typical indices for hip

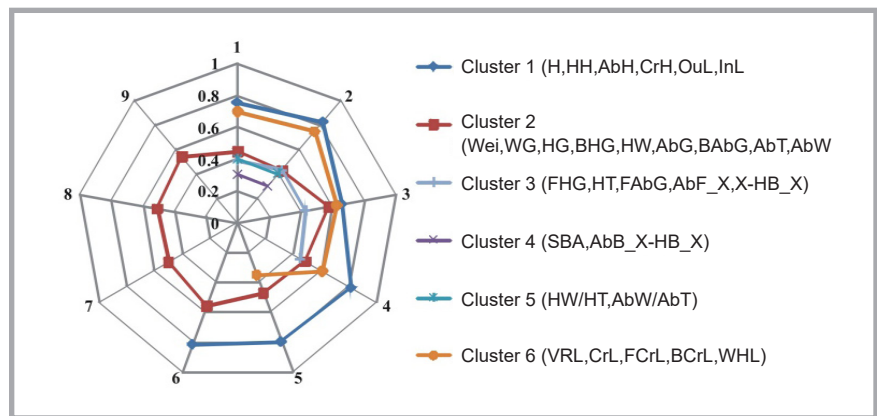

**Figure 9.** Values of  $\bar{r}^2$  in each variable.

**Table 3.** Analysis of variance in typical indices.

Cluster number	Typical indices	CMS	EMS	Test F	P
3	HG	838.129	11.291	74.232	0.000
	HH	1,741.835	12.021	144.905	0.000
	HW/HT	0.048	0.006	7.536	0.001
	CrL	1,280.071	12.196	104.961	0.000
	AbF_X-HB_X	93.871	1.807	51.948	0.000
	AbB_X-HB_X	2.655	2.583	1.028	0.359
4	HG	778.705	9.039	86.153	0.000
	HH	1,475.280	8.791	167.820	0.000
	HW/HT	0.039	0.006	6.217	0.000
	CrL	987.415	10.842	91.075	0.000
	AbF_X-HB_X	90.603	1.521	59.554	0.000
	AbB_X-HB_X	2.040	2.589	0.788	0.502
5	HG	714.160	7.256	98.417	0.000
	HH	1,076.279	9.242	116.454	0.000
	HW/HT	0.036	0.006	5.816	0.000
	CrL	879.130	8.948	98.245	0.000
	AbF_X-HB_X	77.116	1.399	55.124	0.000
	AbB_X-HB_X	7.894	2.510	3.146	0.015

**Table 4.** New shape sizing chart.

Typical indices	Class				
	Type 1	Type 2	Type 3	Type 4	Type 5
HG, cm	90.42	91.72	92.74	94.61	86.99
HH, cm	93.54	86.91	78.83	78.69	76.54
HW/HT	1.48	1.49	1.49	1.47	1.52
CrL, cm	49.66	66.86	61.69	67.80	61.44
AbF_X-HB_X, cm	24.00	24.54	24.75	25.86	23.25
AbB_X-HB_X, cm	4.30	3.83	2.98	3.45	3.75
Number in each cluster	5	43	65	79	100
Percentage of each size, %	1.7	14.7	22.3	27.0	34.3

**Table 5.** Confusion matrix comparisons for hip shape classification using the PNN, BP and SVM schemes.

Annotation\ Recognized	PNN					BP					SVM				
	A	B	C	D	E	A	B	C	D	E	A	B	C	D	E
A	2	0	0	0	0	2	0	0	0	0	2	0	0	0	0
B	0	11	0	0	0	0	8	0	2	1	0	11	0	0	0
C	0	0	14	1	1	0	0	12	2	2	0	0	13	1	2
D	0	0	2	18	0	0	1	1	18	1	0	0	2	18	0
E	0	0	1	0	24	0	0	1	1	23	0	0	1	0	24

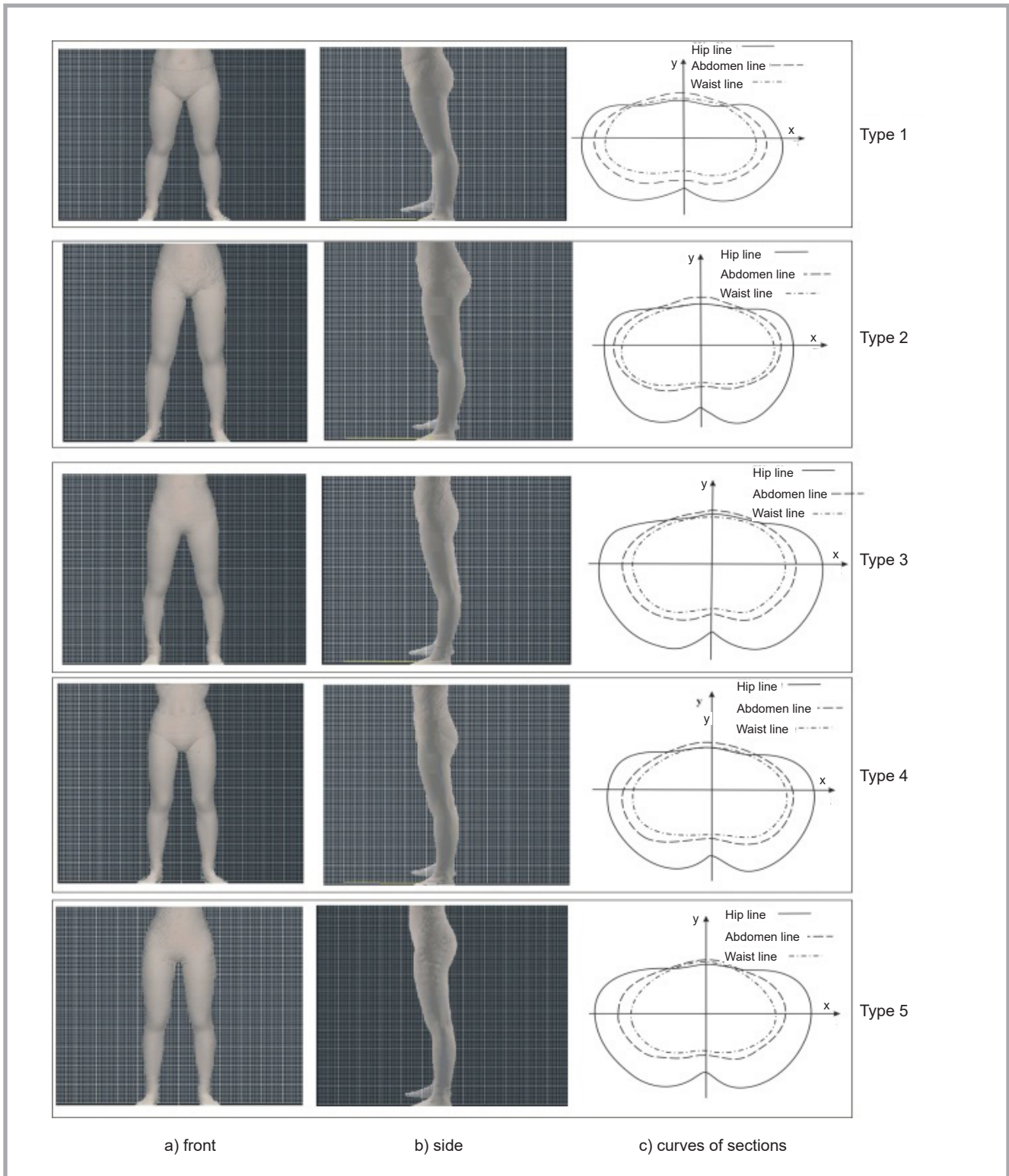

Figure 10. Shape charts of types.

shape type classification. We compared the classification performances of PNN, BP and SVM classifiers. The confusion matrices of hip shape type classification using the PNN, BP and SVM schemes are listed in Table 5. Meanwhile, the sensitivity (SENS), specificity (SPEC), and accuracy (ACCU) of the three classifiers mentioned above for the testing

patterns are summarised in Table 6. SENS represented the number of objects belonging to a class that were correctly classified in the correct class, and SPEC corresponded to objects not belonging to a certain class and subsequently classified as pertaining to another. From Table 6, the model constructed and PNN classifier, we can observe that there

were high classification performances for A and B, with SENS of 100% in both cases. In the case of D and E, SENS was of 90.00% and 96.00%, respectively. C showed the lowest value of SENS, being 87.50% only. Taking into account the values of SPEC ranging from 95.08% to 100%, it could be concluded that the model of PNN classifier proposed pre-

**Table 6.** Classification performance comparisons of the scheme with PNN, BP and SVM classifiers proposed.

Annotation/Classification scheme	PNN, %			BP, %			SVM, %		
	SENS	SPEC	ACCU	SENS	SPEC	ACCU	SENS	SPEC	ACCU
A	100.00	100.00	100.00	100.00	100.00	100.00	100.00	100.00	100.00
B	100.00	100.00	100.00	72.73	98.44	94.67	100.00	100.00	100.00
C	87.50	95.08	93.51	75.00	96.67	92.11	81.25	95.08	92.21
D	90.00	98.18	96.00	85.00	91.53	92.31	90.00	98.18	96.00
E	96.00	98.00	97.33	92.00	92.45	92.31	96.00	96.08	96.05
Average	94.70	98.25	97.37	84.95	95.82	94.28	93.45	97.87	96.85

sented misclassified samples in all classes considered. The best and poorest performances of ACCU of each hip shape type using the BP scheme were 100% for A and 92.11% for C, respectively. When using the SVM scheme, the best and poorest performances were the ACCU of 100% for both A and B, and 92.21% for C, respectively. The PNN scheme could classify A with an ACCU of 100%, B with 100%, C with 93.51%, D with 96%, and E with 97.33%. These results demonstrated that the PNN scheme proposed could classify the five hip shape types effectively. The average value of ACCU of the BP scheme, SVM scheme, and PNN scheme were 94.28%, 96.85%, and 97.37%, respectively. The PNN scheme could outperform the other two schemes because it could reduce the number of misclassifications of hip shape types (i.e., there were 4 misclassifications for C using BP scheme, 3 misclassifications using the SVM scheme, but only 2 for the PNN scheme).

According to **Table 6**, the average SENS, SPEC, and ACCU were improved from 84.95%, 95.82%, and 94.28% to 94.70%, 98.25%, and 97.37%, respectively, by applying the PNN scheme instead of the BP scheme. In addition, the overall performance of the PNN scheme was better than that of the BP scheme by more than 9.7% in SENS, 2.4% in SPEC, and 3% in ACCU, respectively. Therefore it was apparent that the PNN scheme showed the best performances for hip shape type classification.

### Implementation of the model for developing an intelligent classification system

In this paper, the PNN model could be considered as a good shape recognition expert system. By using the model proposed and designing an interface for it, an intelligent decision support system was developed as a shape type recognition expert system that could be used by textile industries. The results were time saving and more convenient for users by

selecting the appropriate model for them to understand their shape types without inputting the numerous items. The intelligent hip shape recognition system implemented is shown in **Figure 11**.

Therefore if the user wants to use such an intelligent system for other persons with various body structures, he just needs to collect data containing six typical indices of body measurements. After that he can use the data collected to form the hip shape types and implement the recog-

nition system. The resulting hip shape recognition system that is constructed through the classification model proposed based on 3D body measurement could be helpful for a large number of persons with the same body measurement to understand their appropriate shape types.

### Conclusions

In this paper, an intelligent model for developing a hip shape recognition sys-

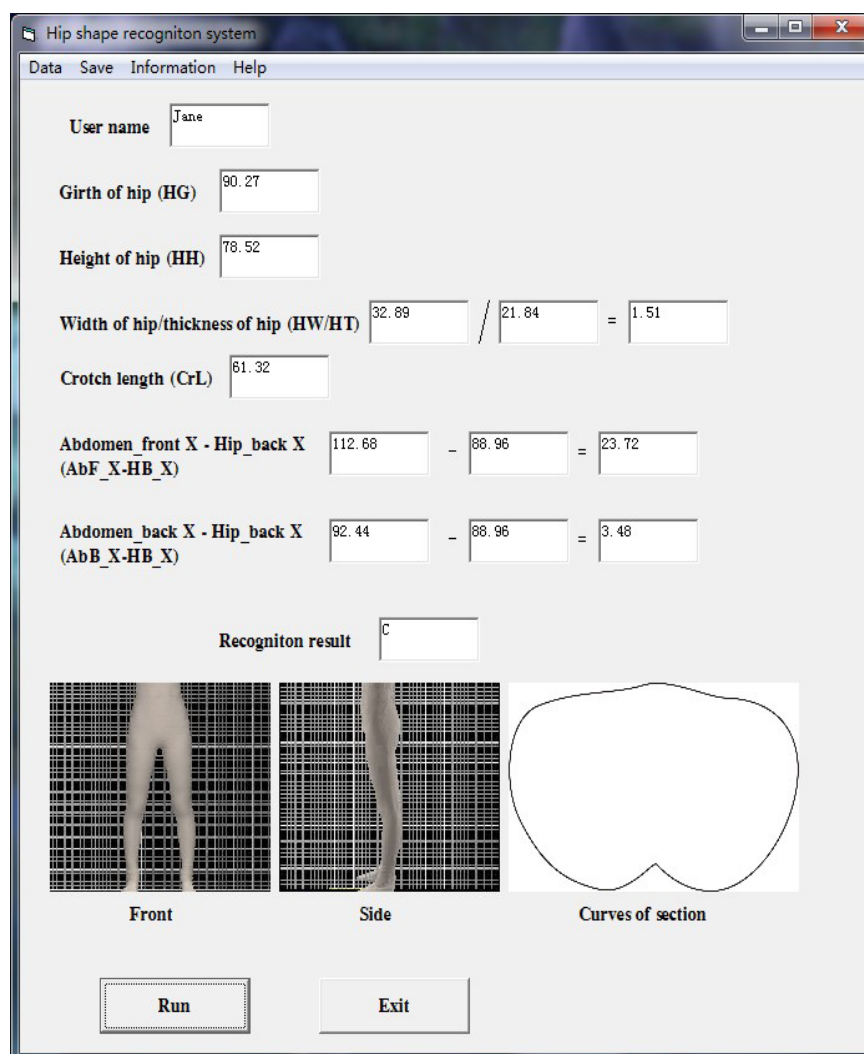

**Figure 11.** Intelligent recognition implemented system.



tem based on 3D body measurement combining cluster analysis and correlation analysis, and a PNN classifier to identify the type were proposed. A 28-dimensional feature vector reflecting lower body part information was selected. In order to reduce the training time and improve classification accuracy of the classifier, the 28-dimensional features were reduced to six typical indices by cluster analysis and correlation analysis. After subdivision of hip shape types by a K-means cluster and analysis of variance, the reduced features were then treated as the inputs of the PNN classifier to discriminate five different types of hip shape. The average classification accuracy of the PNN scheme proposed was evaluated by comparing with the BP and SVM schemes. The scheme proposed achieved a 97.37% rate, which was very promising. Thus it could be considered as a successful recognition system.

When facing large scale data from the 3D body scanner, it is necessary to do feature reduction, and then to develop an appropriate recognition model for identification of the body shape type, as the significant features can characterise a certain body type. If the method in this study is successfully carried out in practice, it will be expected that the system proposed may help industrial practitioners to gain insight into 3D body scanning data for mass customisation in order to satisfy customer requirements for garment fitness.



## Acknowledgments

This work was supported by International Science and Technology Cooperation Project (2011DFB51570), Zhejiang Provincial Natural Science Foundation (No. LQ12E05015), and was supported by the corresponding author Professor Zou Fengyuan as well.

## References

- Hsu CH. Developing accurate industrial standards to facilitate production in apparel manufacturing based on anthropometric data. *Human Factors and Ergonomics in Manufacturing & Service Industries* 2009; 19(3):199-211.
- Choi YL and Nam YJ. Classification of upper lateral body shapes for the apparel industry. *Human Factors Ergonomics Manufacture & Service Industries* 2010; 20(5): 378-390.
- Vuruskan A and Bulgun E. Identification of female body shapes based on numerical evaluations. *International Journal of Clothing Science and Technology* 2011; 23(1): 46-60.
- Zheng R, Yu W and Fan JT. Development of a new Chinese bra sizing system based on breast anthropometric measurements. *International Journal of Industrial Ergonomics* 2007; 37(8): 697-705.
- Lee WY and Imalka H. Classification of body shape characteristics of women's torsos using angles. *International Journal of Clothing Science and Technology* 2010; 22(4): 297-311.
- Armstrong HJ. *Pattern making for fashion design* (5th Edition), New York: Harper Collins.
- Nam YJ. *A study on classification of somatotype based on the lateral view of women's upper body*. Unpublished doctoral dissertation, Seoul National University, Seoul, Korea. 1991.
- Kim SA and Choi HS. Upper body somatotype classification and discrimination of elderly women according to index. *Journal of the Korean Society of Clothing and Textiles* 2004; 28(7): 983-994.
- Na HS. Classification of side somatotype of upper lateral torso analyzing 3D body scan image of American females. *Journal of Korean Society of Costume* 2007; 57(4): 9-17.
- Konar A. *Computational Intelligence: Principles, Techniques*, Springer, Berlin, 2005.
- Wang XF and Huang DS. A novel density-based clustering framework by using level set method. *IEEE Transactions on Knowledge and Data Engineering* 2009; 21(11): 1515-1531.
- Huang DS. A constructive hybrid structure optimization methodology for radial basis probabilistic neural networks. *IEEE Transactions on neural networks* 2008; 19(12): 2099-2115.
- Chen Y, Zeng XY, Happette M and Bruniaux P. A new method of ease allowance generation for personalization of garment design. *International Journal of Clothing Science and Technology* 2008; 20(3): 161-173.
- Hu ZH, Ding YS, Yu XK, Zhang WB and Yan Q. A hybrid neural network and immune algorithm approach for fit garment design. *Textile Research Journal* 2009; 79(14): 1319-1330.
- Zou FY, Hu JL, Zhang SJ and Dong JM. Application of neural network to pattern design of young women's clothing. *AUTEX 2007 International conference*, Tampere, Finland, 26-28 June, 2007.
- Zou FY, Ding XJ and Zhang SY. Application of neural network to identification of young females' body type. In 'Proceedings of the 2006 IEEE International Conference on Systems, Man, and Cybernetics', Taipei, Taiwan, IEEE, 2006; 2257-2261.
- Gori M and Tesi A. On the problem of local minima in backpropagation. *IEEE Transactions pattern analysis and machine intelligence* 1992; 14:76-85.
- Zhang SY, Zou FY and Ding XJ. Research on the young women's body classification based on SVM. *Journal of Zhejiang Sci-Tech University* 2008; 25(1): 41-45.
- Burges CJC. A tutorial on support vector machines for pattern Recognition. *Data Mining and Knowledge Discovery* 1998; 2: 121-167.
- Revett K, Gorunescu F, Gorunescu M, E-Darzi E and Ene M. A breast cancer diagnosis system: a combined approach using rough sets and probabilistic neural networks. the International conference on *Computer as a Tool*: Belgrade, Serbia and Montenegro, November 21-24, 2005; 1124-1127.
- Adeli H and Panakkat A. A probabilistic neural network for earthquake magnitude prediction. *Neural Networks* 2009; 22(7): 1018-1024.
- Kim D, Kim DH and Chang SY. Application of probabilistic neural network to design breakwater armor blocks. *Ocean Engineering* 2008; 35(3-4): 294-300.
- Mantzaris D, Anastassopoulos G and Adamopoulos A. Genetic algorithm pruning of probabilistic neural networks in medical disease estimation. *Neural Networks* 2011; 24(8): 831-835.
- Shahrabi J, Hadavandi E and Esfandarian MS. Developing a hybrid intelligent model for constructing a size recommendation expert system in textile industries. *International Journal of Clothing Science and Technology* 2013; 25(5): 338-349.
- Reynolds AP, Richards G, Iglesia B, DE LA and Rayward-Smith VJ. Clustering Rules: A comparison of partitioning and hierarchical clustering algorithms. *Journal of Mathematical Modeling and Algorithms* 2006; 5(4): 475-504.
- Duda RO, Hart PE and Stork DG. *Pattern classification*. 2nd ed. Wiley-Interscience, 2000.
- Kovács F, Legány C and Babos A. Cluster Validity Measurement Techniques, in *Proceedings of the fifth WSEAS International Conference on Artificial Intelligence, Knowledge Engineering and Data Bases*, Madrid, Spain, 2006; 388-393.
- Specht DF. Probabilistic neural networks. *Neural Networks* 1990; 3: 109-118.
- Forina M, Armanino C, Leardi R and Drava G. A class-modelling technique based on potential functions. *Journal of Chemometrics* 1991; 5(5): 435-453.

Received 05.05.2014 Reviewed 14.03.2016