

# Investigation into Navel Selection for Rotor Spinning Machine Using Cotton Waste

## Abstract

In this study, we investigated the effects of some navel properties such as form, number of grooves, fluted insert, material, lengths of ceramic part and grooves on rotor yarn spun from 100% cotton waste. Ten navels with different technical properties were used for spinning coarse (49-tex) rotor yarn. Finally, by considering the raw material characteristics, results regarding the relations between navel properties and rotor yarn quality were put forward. Some information concerning the selection of the proper navel for these conditions was also given. According to the results, the best values for evenness and imperfections were obtained by using plain steel navel (SGF); spiral ceramic navel (KS) showed a better performance than SGF for the properties directly related to deformation given to yarn, such as hairiness, tenacity and elongation. These results are attributed to the minimum deformation given by these navels to yarn spun from cotton with very high short fibre and impurity content.

**Key words:** navel, groove, fluted insert, cotton waste, rotor yarn quality.

mill that no other spinning system exists enabling this economical application. As a rule, raw material should be selected in such a way as to build a balance between raw material cost and desired yarn characteristics.

To obtain a good spinning stability, the yarn must have sufficient twist at the peeling point where it leaves the rotor groove. The necessary twist is created by the help of the navel. The location of this specific part in the yarn withdrawal passage of the spindax is shown in Figure 1. The yarn drawn from the rotor groove takes a 90° turn inside the navel. The rotation of the yarn around the inner wall of the navel creates an additional false twist on the yarn between the rotor groove and the yarn draw-off tube. This action, which is shown schematically in Figure 2, ensures a high twist moment, enabling the propagation of twist in the rotor groove and an increase in yarn tenacity.

In addition to causing tension breaks, higher rotor speeds increase the false twist effect, and when smooth navels are used in this condition, overtwisting and yarn ruptures can occur. Therefore, grooves are cut or pressed into the navel which briefly lift the yarn off the navel surface, thus causing the catenary to vibrate at high frequencies. These vibrations facilitate the twist's propagation into the rotor groove [2]. There is an optimum depth of roughness for a particular fibre and yarn type. Yarn properties as a function of navel design are shown in Figure 3.

Simpson & Patureau [3] claimed that yarns spun with a coarsely-grooved

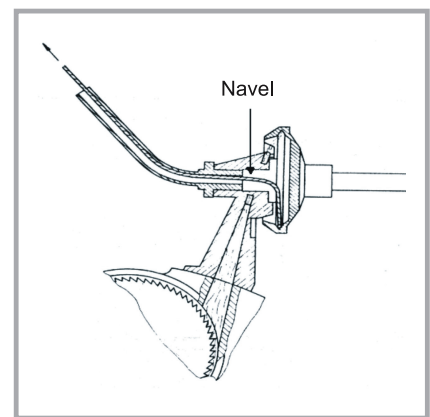

Figure 1. Yarn withdrawal passage of spindax [1].

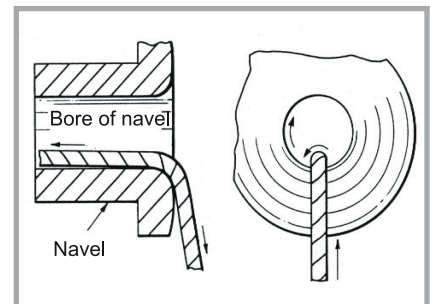

Figure 2. The rotation of the yarn around the inner wall of the navel [2].

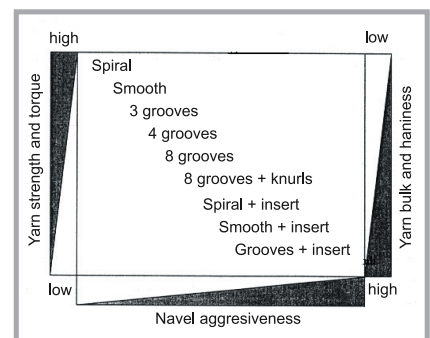

Figure 3. Yarn properties as a function of navel design [2].





navel had lower tenacity and higher evenness values than those spun with a finely-grooved navel. Marino et al. [4] observed the effects of navel properties on yarn quality parameters more prominently on polyester yarns than cotton yarns, and the behaviour of polyester/cotton blend fibre yarns similar to cotton yarns. Lawrance & Chen [5] defined the ratio between draw-off tension measured downstream of the doffing tube ( $F_2$ ) and the calculated tension in the yarn tail between the navel and the rotor wall ( $F_1$ ) as a very important factor for controlling false twist, and reported that this ratio should not exceed a value of 2 to improve the false-twist effect. They also stated that  $F_2$  was affected by the navel's frictional properties. Manich et al. [6] pointed out that the difference between 'machine twist' and 'yarn twist' increased linearly in conditions when both the yarn linear density and twist multiplier increased, as likewise the navel funnel diameter

or the number of grooves on the navel. Trommer [7] claimed that increasing the friction between the yarn and the navel was not a good solution for obtaining higher friction moment on the yarn axis, as this application could cause damage to man-made fibres like polyester. It was also added that grooved navels were necessary if only small rotor diameters, low twist values and fibres with high trash contents were used. McCreight et al. [8] found that additional twist created inside the navel and increased in the yarn draw-off tube caused higher yarn evenness values. Copeland et al. [9] stated that fluted inserts and grooves increased yarn hairiness and fly. As the number of grooves increased and spiral navels were combined with fluted inserts, yarn evenness and imperfection values were also increased, in addition to yarn hairiness. Merwe et al. (1978) investigated the effect of yarn contact length with the navel surface, and observed that when a 2-mm

washer was inserted between navel and rotor, yarn tenacity increased, and hairiness and neps values decreased [10]. In a similar study by Hergeth et al. [10], by inserting a 1.5 mm washer between the rotor and the navel, it was concluded that yarn friction increased but evenness values were not affected by the washer.

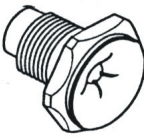
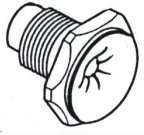
The navel is one of the most examined component of the spinbox as it has a decisive effect on rotor yarn properties. Different technical designs for navels are present on the market for different subsequent uses and spinning conditions. This paper aims to compare the performances of ten selected navels which are commonly used by rotor yarn producers, and put forward some conclusions regarding the selection of the appropriate navel for the specific application carried out in this study, namely the spinning of 49-tex (Ne 12) rotor yarn from 100% cotton waste.

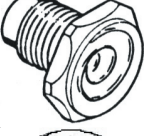
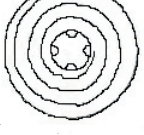
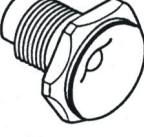
Table 1. Technical properties of navels.

Navel type	Navel symbol	Navel properties					Material
		Navel design	Number of grooves	Navel length	Fluted insert	Groove length	
K4K	A		4	Long	-	Short	Ceramic
K4KK	B		4	Short	-	Short	Ceramic
K4KD	C		4	Long	-	Long	Ceramic
S4KF	D		4	Short	-	Short	Steel
K8KK	E		8	Short	-	Short	Ceramic
K4KS	F		4	Long	+	Long	Ceramic
KS	G		0 (spiral)	Short	-	-	Ceramic
KKSS	H		0 (spiral)	Long	+	-	Ceramic
SGF	J		0	Short	-	-	Steel
S3KF	K		3	Short	-	Short	Steel

## Material and methods

### Material

Ten navels with different technical properties were used to spin 49-tex (Ne 12) rotor yarn from cotton waste. The contents of the waste were 40% combing noil, 30% card waste, 20% blowroom waste, and 10% wastes from the pneumofil device.

### Method

The technical properties of the navels used in the study, as they differed in their materials, forms, number of grooves, the presence of fluted inserts, lengths of ceramic parts and grooves, are given in Table 1. The spinning conditions and machine settings used in the study are given below:

Machine type: Rieter RU 04 (1995)  
 Rotor type: Nitrate coated steel (40 - 42°)  
 Rotor speed: 65,000 rpm  
 Rotor diameter: 40 mm  
 Opening-roller speed: 8,500 rpm  
 Draw-off tube: soft twist  
 Take-up speed: 93 m/min  
 Twist coefficient ( $\alpha_c$ ): 5.1  
 Draft: 92  
 Sliver count: 4.54 ktex (Ne 0.130)

The yarn parameters measured were as follows: uniformity and imperfections on an Uster Tester IV-SX (10 standard tests for each navel type at a traversing speed of 400 m/min); tenacity and elongation-

to-break on an Uster Tensorapid IV (10 standard tests for each navel type at a speed of 5000 m/min and 5 breaks for each package). Tests were carried out under standard atmospheric conditions (RH 65 ± 2% and 20 ± 2 °C).

SPSS 10.0 Statistics Software was used for statistical analysis of the results. The One-Way-Anova Test was applied, and the average values were compared at a 5% significance level and grouped according to the Duncan Multiple Range Test.

### ■ Test results and discussions

The experimental quality results obtained for 49-tex rotor yarn are compiled in Table 2. The statistical analysis results of yarn properties spun by using ten different navels are given below, together with detailed explanations of the results.

#### Evenness (U%):

Minimum yarn evenness values were obtained by using smooth steel (SGF) and ceramic spiral (KS) navels. The common property of these two navels is their smooth inner surface. These navels yield less deformation and twist variation on yarn during the false twist creation process. 4-groove long (K4K) and short (K4KK) ceramic navels (with short grooves) showed the same performances with a spiral ceramic navel (KS); this confirms the result of a preceding study [1]. According to this result, it can be concluded that besides a certain degree of deformation given to the yarn, the rough surface characteristics have to some extent a positive effect in waste removal from the yarn. It is thought that this result became clearer because of the high waste and short fibre content of the raw material used. As 4-groove (K4K and K4KK) and 8-groove (K8KK) ceramic navels had the same performances as 3-groove (S3KF)

and 4-groove (S4KF) steel navels respectively, it can be said that grooves on steel navels have a greater effect on yarn deformation than the grooves on ceramic navels. As a 4-long groove ceramic navel (K4KD) had the same performance as a navel with 4 grooves and a fluted insert (K4KS), it can be concluded that fluted inserts in grooved navels do not affect yarn evenness under these conditions. Although spiral ceramic navels (KS) gave minimum yarn evenness values, the yarn spun by using a spiral ceramic navel with a fluted insert (KKSS) had maximum evenness values. This result confirms a preceding study [9], that the fluted insert in spiral ceramic navels has a negative effect on coarse rotor yarn evenness because of the excessive deformation and tension fluctuations which occur on the yarn. A box-plot diagram of the performances of navels for evenness values is shown in Figure 4.

#### Yarn imperfections (thin-thick places and neps):

Similar to the results obtained for yarn evenness, minimum thin places (-40% and -50%) were obtained by using smooth steel (SGF) and spiral ceramic (KS) navels; maximum values were obtained with 4-groove long ceramic (K4K) and 4-groove long ceramic navels with fluted insert (K4KS). In addition, it can be concluded that results of -40% thin places harmonise better with the results of yarn evenness, and the navel properties have a smaller effect on -50% thin place values.

Parallel to the results obtained for other yarn imperfections, minimum thick places (+35% and +50%) were obtained by using a smooth steel navel (SGF). The result about the greater effect of grooves on yarn deformation in steel navels than ceramic navels is also valid for thick-place results. Generally, it

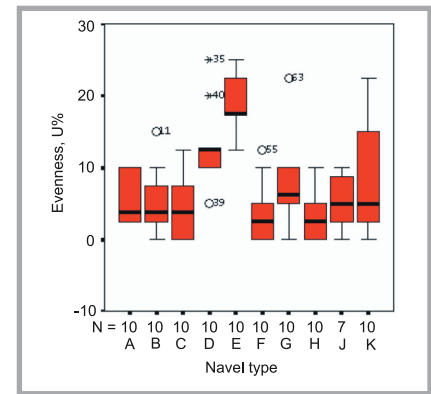

Figure 4. Box-plot diagram showing influence of navel properties on 49-tex rotor yarn evenness (U%).

can be concluded that the length of the ceramic part, the fluted insert added to spiral navel, the number of grooves on ceramic navels, the material of the navel does not have any effect on +50% the thick places of the 49-tex rotor yarn. In contrast to the evenness and thin place (-40% and -50%) results, a fluted insert added to the 4-long groove ceramic navel (K4KS) decreased the thick place (+35% and +50%) values.

Minimum nep (+200% and +280%) values were obtained for the yarn spun with a smooth steel navel (SGF). According to the results, navel form, navel length, the material of the navel and the fluted insert in the spiral ceramic navel do not have any effect on the neps (+200% and +280%) values of 49-tex yarn. Similar to the results of thick places (+35% and +50%), grooves on steel navels have a greater effect on yarn deformation and fluted insert in 4-long groove navel (K4KS) has a positive effect on yarn nep (+200% and +280%) values. Especially for +280% nep values, this effect was clearer because K4KS was in the same group with the spiral ceramic navel (KS) which always gave good results for evenness and imperfection values. This result

Table 2. Yarn properties obtained by using different navel types.

Yarn Properties	K4K	K4KK	K8KK	K4KD	K4KS	KS	KKSS	SGF	S3KF	S4KF
Uster %CVm	15,01	14,90	15,56	16,17	16,11	14,76	15,91	14,44	15,06	15,32
IPI Thins (-40%)	210,3	205,5	258,8	418,5	457,3	187,0	318,5	128,5	188,9	16 253,3
IPI Thins (-50%)	5,3	5,0	4,8	13,0	18,8	4,0	7,5	2,8	5,4	7,8
IPI Thicks (+35%)	690,0	688,3	790,5	1042,0	940,5	639,5	819,3	545,8	661,1	799,0
IPI Thicks (+50%)	119,0	122,0	136,8	187,8	134,0	115,5	116,5	86,0	100,4	140,8
IPI Neps (+200%)	878,5	837,0	1135	1551	1053,0	929,3	1079	555,3	831,4	1032,0
IPI Neps (+280%)	159,8	156,5	196,8	256,0	151,0	161,3	142,3	96,8	133,6	182,5
Hairiness (H)	6,92	7,77	9,46	8,79	12,10	6,20	11,57	6,68	7,91	7,87
Tenacity, cN/tex	9,10	9,10	9,07	8,66	9,19	10,23	8,46	9,46	9,02	9,86
Elongation, %	6,33	6,55	5,97	6,40	6,60	7,00	6,18	6,55	6,19	6,95

is thought to be a consequence of the effect of opening and trash removal on the inner surface of K4KS. As the box-plot diagrams of imperfection values for different percentages are similar, only the diagrams of 50% thin and thick places and 280% nep values were compiled in Figures 5, 6 and 7.

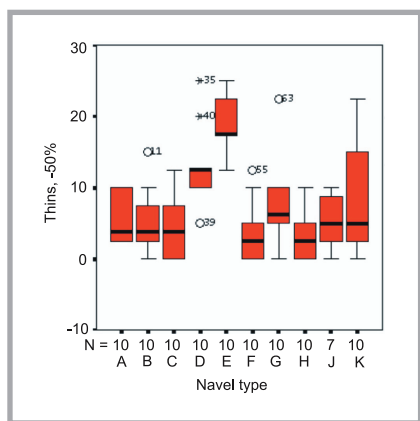

Figure 5. Box-plot diagram showing influence of navel properties on thin places (-50%) of 49-tex rotor yarn.

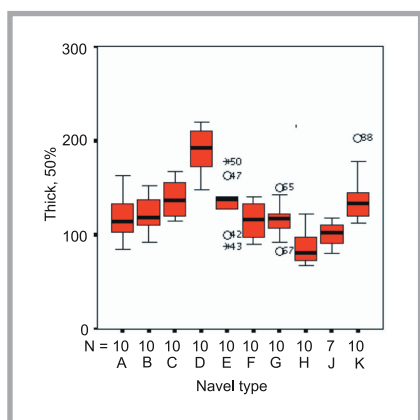

Figure 6. Box-plot diagram showing influence of navel properties on thick places (+50%) of 49-tex rotor yarn.

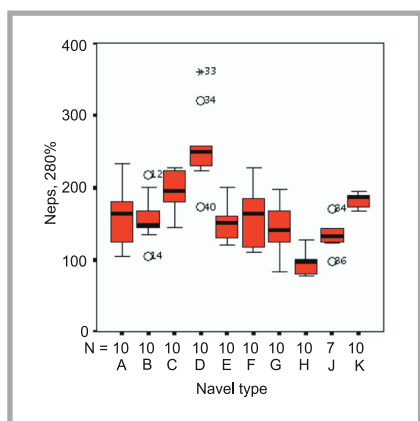

Figure 7. Box-plot diagram showing influence of navel properties on nep (+280%) values of 49-tex rotor yarn.

### Hairiness (H):

Minimum hairiness values for 49-tex rotor yarn were obtained by using a spiral ceramic navel (KS). Regarding evenness and imperfection values, the spiral ceramic navel (KS) showed a better performance than the smooth steel navel (SGF) in those properties which are affected directly by yarn deformation such as yarn hairiness, tenacity and elongation. This result is thought to be caused by the minimum deformation given to the yarn by the spiral ceramic navel (KS) which creates fewer protruding fibre ends on yarn spun from a raw material consisting of cotton waste. It was observed that the influence of the navel's inner wall characteristics on hairiness is more explicit than an other yarn properties. As 4-groove ceramic and steel navels (S4KF and K4KK) had the same performances, it can be concluded that the material of the navel does not influence the 49-tex rotor yarn hairiness. Spiral and 4-groove ceramic navels with fluted inserts (K4KS and KKSS) showed the worst performances regarding yarn hairiness because of the extra roughness on their inner surfaces. A box-plot diagram for the hairiness values of 49-tex yarn is given in Figure 8.

### Tenacity (cN/tex):

The maximum tenacity (cN/tex) values for 49-tex rotor yarn were obtained by using spiral ceramic (KS) and 4-groove steel (S4KF) navels. According to the results, it can be concluded that yarn tenacity is not significantly affected by navel length, groove length/number or the material of the navel. It was observed that although the fluted insert in 4-groove navel did not have an effect yarn tenacity, the fluted insert in the spiral ceramic navel considerably decreased yarn tenacity. In general, the differences between navel performances are statistically insignificant for tenacity and elongation but significant for hairiness. Therefore, it can be said that the navel properties had a greater influence on 49-tex rotor yarn hairiness than the other two properties. Figure 9 illustrates the box-plot diagram for tenacity values of 49-tex yarn.

### Elongation (%):

Similar to the results for tenacity, maximum elongation (%) values for 49-tex rotor yarn were obtained by using spiral ceramic (KS) and 4-groove steel (S4KF) navels. Results for similar performances of 8-groove short ceramic (K8KK) and

3-groove steel (S3KF) navels for tenacity and elongation confirms that grooves on steel navels have a greater effect on yarn deformation than ceramic navels. In addition, no effects of navel form, navel/groove lengths or the material of the navel were observed on yarn elongation (%) according to these results. Simi-

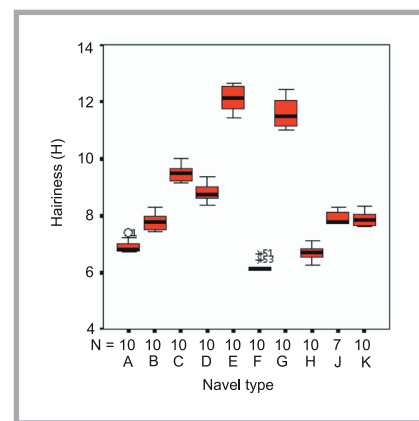

Figure 8. Box-plot diagram showing influence of navel properties on hairiness of 49-tex rotor yarn.

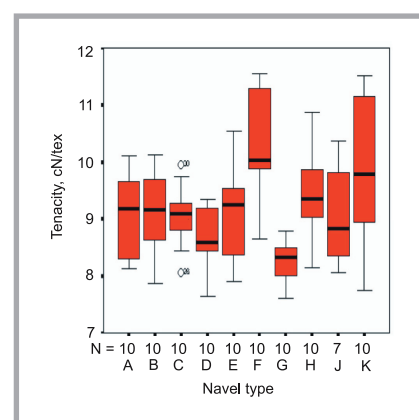

Figure 9. Box-plot diagram showing influence of navel properties on tenacity (cN/tex) of 49-tex rotor yarn.

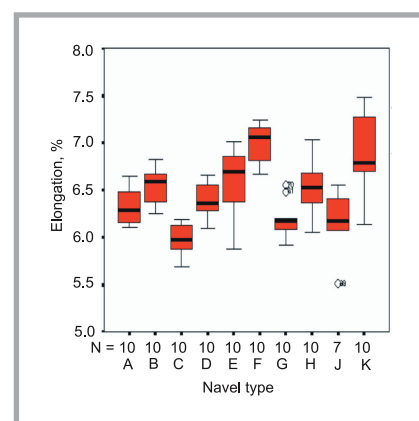

Figure 10. Box-plot diagram showing influence of navel properties on elongation (%) of 49-tex rotor yarn.



lar to the tenacity results, the fluted insert in the spiral ceramic navel affected yarn elongation negatively. Figure 10 shows the box-plot diagram for elongation values of 49-tex yarn.

## ■ Conclusions and suggestions

According to the study reported in this paper about the influence of navel properties on coarse (49-tex) rotor yarn spun from cotton waste, the best evenness and imperfection (thin, thick and nep) values were obtained by using a smooth steel navel (SGF). The spiral ceramic navel (KS) showed a similar performance with a smooth steel navel (SGF) in yarn evenness and thin places (-40,% and -50%). Navels with 4-long grooves (K4KD) and 4-long grooves with a fluted insert (K4KS) gave maximum yarn evenness and thin place (-40,% and -50%) values as a result of the higher friction coefficient created between the navel and the yarn during twist insertion. But this rough surface affected the thick-place, and especially the nep values positively, because of the opening and trash removal action applied to the yarn produced from high short fibre and impurity content.

Hairiness values of 49-tex rotor yarn were affected directly by navel properties; minimum hairiness values were obtained by using the spiral ceramic (KS) navel, maximum values were obtained by using the 4-groove ceramic navel with a fluted insert (K4KS). As a result of their rough surface characteristics, the 4-groove and spiral ceramic navels with fluted inserts affected hairiness values negatively.

The maximum tenacity (cN/tex) and elongation (%) values were obtained by using the spiral ceramic navel (KS), and minimum values were obtained by using the spiral ceramic navel with a fluted insert (KKSS). These results can be attributed to the deformation given to the yarn by the KKSS having a rough surface. The fluted insert affected yarn properties differently; when it is added to a grooved navel, it primarily affects the surface's characteristics, and consequently the nep and hairiness values of the yarn; but if it is added to a spiral navel, it causes greater deformations, thus decreasing the tenacity and elongation values of the yarn.

Summing up, the most suitable navel for coarse rotor yarn (49-tex) produced from 100% cotton waste varies according to the most important property for the

consequent use of this yarn. If minimising yarn evenness and imperfections is the goal of the production process, the smooth steel navel (SGF) should be selected; if hairiness, tenacity and elongation are the most important criteria for yarn, the spiral ceramic navel (KS) is the appropriate one for this case. Finally, it can be concluded that selection of the most suitable navel for a production process is determined by the raw material characteristics, the degree of importance of the yarn's properties for subsequent use, and other process parameters. The results put forward in this study are valid only for this particular case, and may be completely different for another type of yarn production process.

## References

1. Klein, W., 1993. *New Spinning Systems. Short Staple Spinning Series, Volume: 5, The Textile Institute, Manual of Textile Technology*, p. 42-44, England.
2. Deussen, H., 1993. *Rotor Spinning Technology, Schlafhorst Publications*, p. 61-64, North Carolina.
3. Simpson, J., Patureau, A. M., August-1979. *Effect of Rotor Speed on Open-End Spinning and Yarn Properties. T.R.J.*, 468-473.
4. Marino, P. N., Garofalo, J., Barella, A., Manich, A. M., 1984. *Factorial Studies in Rotor Spinning Part II: Polyester-Fibre and Polyester-Fibre-Cotton Blended-Fibre Yarns. J.T.I.*, 23-27.
5. Lawrence, C.A., Chen, K.Z., 1984. *Rotor-spinning. The Textile Institute, Textile Progress, Volume: 13, Number: 4*, p. 17-19, England.
6. Manich, A., De Castellar, Barella, A., D., March-1986. *Influence of a Yarn Extractive Nozzle on the Apparent Loss of Twist in Rotor Open-End Acrylic Staple Spun Yarns. T.R.J.*, 207-211.
7. Trommer, G., 1996. *Open End İplikçiliğinde Eğirme Stabilesini Etkileyen Başlıca Faktörler. Tekstil Maraton*, 4, 20-24.
8. McCreight, D.J., Feil, R.W., Booterbaugh, J.H., Backe, E.E., 1997. *Short Staple Yarn Manufacturing*, p. 358-363, England.
9. Copeland, A.D., Hergeth, H.H.A., Smith, G., 1999. *Çekme Düzesi Formunun Open End İpliği Kalitesi Üzerindeki Etkileri. Tekstil Maraton*, 6, 38-42.
10. Hergeth, H., Copeland, A., Smith, G., 1999. *Open-End Eğirmede Rotor ile Çekme Düzesi Arasındaki Uzaklığın İplik Kalitesi Üzerindeki Etkileri. Tekstil Maraton*, 1, 34-35.
11. Kinneer, P.R., Gray, C.D., 1994. *SPSS For Windows (made simple). Lawrence Erlbaum Associates, Publishers*, 275 p. UK.

■ Received 01.03.2005 Reviewed 30.01.2006



## International Symposium 'Nanotechnologies in Textiles'

### INTERNANO-TEX

3-4 October, 2006, Łódź, Poland



#### Organisers:

- Technical University of Łódź, Faculty of Textile Engineering and Marketing, Department of Man-made Fibres;
- Polish Textile Association

#### Programme frame:

- Nanotechnologies in textiles.
- Preparation methods of nanofibres.
- Fibres containing nanoparticles with special properties.
- Methods of evaluating properties of nanofibres and nanocomposites.
- Modification of nanofibres and nanocomposite textiles.
- Interactive nanofibres and nanocomposites.
- Application of nanofibres and nanocomposites.

The aim of the symposium is to bring together people from academia and industry to discuss the potential of this rapidly evolving field, and to promote co-operation which would enable the development of the full potential of nanotechnology. INTERNANO-TEX promotes the exchange of information between people from industry and universities actively involved in developing nanotechnology applications.

**For more information please contact:**  
 Żeromskiego 116, 90-543 Łódź, Poland  
 Tel.: +48(42)631 33 62  
 Fax: +48(42) 637 20 40  
 E-mail: internanotex@mail.p.lodz.pl