

Ying Wang<sup>1</sup>,  
Jianfeng Li<sup>1</sup>,  
Hui Li<sup>1</sup>,  
Xiaodan Wang<sup>1</sup>,  
Hong Lei<sup>1</sup>,  
Jichuan Huo<sup>2\*</sup>

# Chitosan Modified Corn Starch and Its Application as a Glass Fiber Sizing Agent

DOI: 10.5604/01.3001.0010.1699

## Abstract

*Chitosan-modified corn starch was prepared and then applied as a glass fiber sizing agent. The effect of the chitosan on starch-based emulsion, film and sized glass fiber was studied. When 5 % of the chitosan was added, the overall performance of the modified film-forming agent was optimal. The viscosity, surface tension and zeta potential of the sizing agent were 44.99 mPa·s, 51.29 mN·m<sup>-1</sup> and 4.5 mV, respectively. The modified sizing agent could easily spread over the surface of glass fibre, and conglutinated to the glass surface firmly. The tensile strength and stiffness of modified-starch glass fiber reached 0.43 N·tex<sup>-1</sup> and 4.96 cm. Glass fiber with good overall performance was obtained.*

**Key words:** glass fiber, sizing agent, corn starch, chitosan, modification.

<sup>1</sup>School of Materials Science and Engineering,  
Southwest University of Science and Technology,  
Mianyang 621010, P. R. China

<sup>2</sup>Analytical and Testing Center,  
Southwest University of Science and Technology,  
Mianyang 621010, P. R. China  
\*E-mail: huojichuan168@163.com

## Introduction

Glass fiber is an inorganic material with numerous excellent properties. In recent years, it has been applied in traditional industry and agriculture fields. Due to its high mechanical strength and good corrosion resistance performance, glass fiber is applied in both the form of textile products and as reinforcing material in composite materials [1, 2]. Furthermore sizing is a critical procedure for the production of glass fiber. A sizing agent can provide temporary protection to warp yarns from abrasive and other stress generated on weaving machines, so as to reduce warp damage [3, 4], which bundles thousands of scattered glass fiber filaments into yarn [5, 6].

Traditionally a paraffin-based sizing agent is used in the glass fiber textile industry. However, it contains dicyan-diamide-formaldehyde polycondensate [7], which can barely be removed in the heat cleaning process, resulting in yellow or brown stripes on the cloth obtained. Therefore the paraffin-based sizing agent is gradually being replaced by a starch-based sizing agent, which is mainly produced from renewable and eco-friendly materials [8]. A starch-based sizing agent has advantages of good adhesion, low cost, environmental protection, low thermal decomposition temperature and easy removal. However, the aqueous suspension of a pristine starch sizing agent is unstable and the film formed is usually brittle, which limits the direct use of pristine starch. Starch can be modified through physical, chemical and enzymatic modification of hydroxyl [9, 10]. In the chemical modification of starch, environmental and safety problems caused by the introduction of chemical reagents and by-products are unavoidable. Therefore the starch safety and environmental protection of the chemical modification method have been questioned. In recent years, more and more attention has been paid to non-chemical modification methods. The simple mixing of starch and polysaccharides and the dry-heat treatment of starch-polysaccharide complexes have been carried out in many fields, such as food, textile, military, medicine and environmental protection [11, 12].

Chitosan is the only natural cationic polysaccharide in the world. It has the advantages of good sizing, adhesion and degradation properties [13]. Chitosan is used to prepare a cationic-modified corn starch sizing agent through simple physical modification in order to improve

the performance of the starch film, and it will not pollute the environment [14, 15]. Studies have proved that this method is simple and low cost, which can manufacture a sizing agent with good performance and consequently obtain well-sized textile yarns [16]. A cationic-modified starch sizing agent is widely applied in many enterprises. Considering the anionic property of a glass surface, the cationic-modified corn starch sizing agent is expected to wet and lubricate glass fiber effectively according to the electrostatic adsorption and electronic theory of the bonding mechanism [17]. The present studies focus on the preparation process and reaction mechanism of a chitosan-modified starch sizing agent. The effect of chitosan content on the properties of the modified starch sizing agent, the starch film formed as well as on the sized glass fiber yarns has been studied [18, 19].

In the present work, the amylose content of starch was determined as it may influence the properties of the film formed. The molecular structure change in starch was determined by Fourier transform infrared spectroscopy (FT-IR). Viscosity, particle size, surface tension, contact angle and zeta potential measurements were applied to investigate the wettability of the sizing agent. Solution stability, moisture absorption of the starch film, stiffness, the combustible-matter content and migration were used to show the properties of the modified sizing agent. Tensile strength was used to evidence an improvement in the modification of mechanical properties of the yarns. Furthermore the surface of glass fiber yarns and the distribution of elements in the starch films were obtained by SEM and EDS Mapping to show the improvement in starch-modification.

## ■ Experimental

### Materials

Corn starch with an apparent viscosity of 35 mPa·s was supplied by Xiadian Cornstarch Development Co, Ltd. (Xian, Shanxi Province, China). Chitosan, technical grade, with a deacetylation degree of 85%, was supplied by Golden-Shell Pharmaceutical Co, Ltd. (Taizhou, Zhejiang Province, China). Analytical pure reagents including acetic acid, acetone, glycerol, etc. were supplied by Kelong Chemical Co., Ltd. (Chengdu, Sichuan Province, China). All the chemicals were used as received without further purification.

### Methods

#### Preparation of pristine glass fiber

To remove the sizing agent on the glass fiber and obtain pristine glass fiber for our experiments, EC9-34 glass fiber (68 tex), supplied by Sichuan Fiberglass Group Co., Ltd. (Sichuan, China), was placed in an airtight container with acetone for 48 h. After cleaning up, the glass fiber was dried at 60 °C in a vacuum oven for 24 h before further use.

#### Preparation of chitosan-modified corn starch sizing agent

Corn starch (15 g) was mixed with 300 mL of distilled water in a three-neck flask (500 ml) equipped with a condenser and mechanical stirrer. The mixture was placed in a water bath of 90 °C, and continuously stirred at a speed of 100 rpm for 1 h to obtain gelatinised starch. Chitosan (2.5%, 5%, 7.5% and 10%, respectively) was then dissolved in 100 ml acetic acid solution (3 wt. %). Subsequently chitosan solution was added to the three-neck flask. After 2 hours' reaction, the suspension was cooled down to room temperature and the sizing agent was thus prepared.

#### Preparing of starch film

The chitosan-modified starch sizing agent (10 ml) was pasted on a teflon board and glass board, respectively, and then dried at 45 °C for 12 h. The film formed was preserved in a desiccator for further testing.

#### Sizing glass fiber with modified starch sizing agent

A setup simulating the industrial glass fiber drawing process was designed, as schematically illustrated in **Figure 1**. The linear velocity of the glass fiber yarn passing through the pool of sizing agent

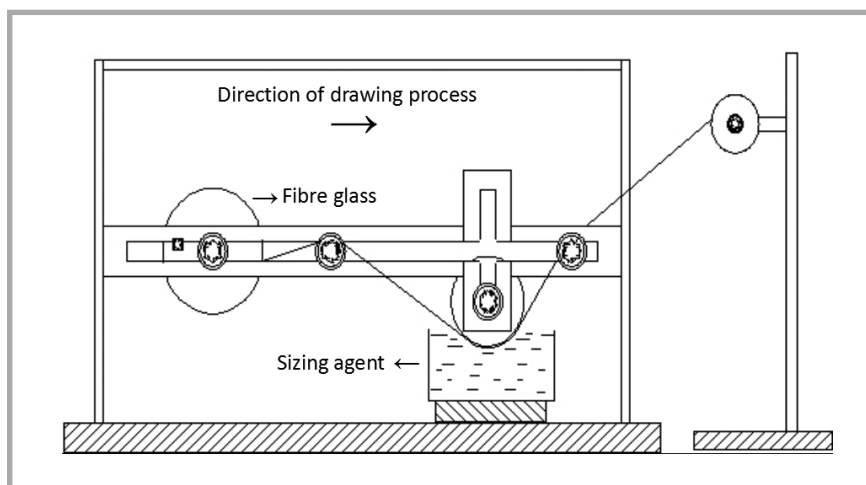

**Figure 1.** Scheme of the setup for glass fiber sizing.

was controlled at 50 m·min<sup>-1</sup>. Then the sized yarn was dried at 50 °C for 48 h and finally preserved in a desiccator [20].

### Characterisation

#### Determination of corn starch amylose content

In accordance with the standard ISO 6647-1:2007 Rice—determination of amylose content, the amylose content of the corn starch was determined. A series of standard starch solutions of different amylose content were prepared and their UV-absorbances determined. With the amylose content as abscissa and the absorbance as ordinate, respectively, a standard curve was drawn. The absorbance of the testing sample was measured at 720 nm, with each measured thrice in parallel.

#### FTIR spectroscopy

The starch films were analysed on a Nicolet 5700 FT-IR spectrophotometer (Perkin-Elmer Co, USA). The spectra were obtained in the range of 400–40000 cm<sup>-1</sup>.

#### Viscosity and particle size measurement

The apparent viscosity of the modified corn starch sizing agent was measured with a DV-||+Pro Rotational Viscometer (Brookfield Co, USA). The particle size of the sizing agent was measured by a MS 2000 Laser Particle Size Analyzer (Malvern Co, UK). The data reported were the averages of three successful tests.

#### Surface tension and contact angle measurement

A K-100 Tensiometer (Kruss Co, Germany) was used to measure the surface

tension of the modified sizing agent. Ten milliliters of the solution was taken and the surface tension measured with the pendant drop method at 25 °C. The data reported were the averages of ten successful tests. A DSA30 Contact Angle Test Instrument (Kruss Co, Germany) was used to measure the static contact angle between the modified agent and glass board surface.

#### Zeta potential measurement

One milliliter of the modified corn starch sizing agent was dissolved in 200 ml of deionised water with ultrasonic oscillation for 1 hour. Subsequently the Zeta potential of the solution was tested with a Zeta-PALS.90 Plus Potential Analysis System (Brookharen Co, USA).

#### Solution stability measurement

The measurement of solution stability included sedimentation stability and retrogradation stability measurements. For the sedimentation stability measurement, 200 ml of the sample solution was placed in a beaker (500 ml) and kept in a water bath of 30 °C. After different hours (6 h, 12 h, 24 h, 48 h) of placement, the volume percentage of the upper aqueous phase was recorded as an index to indicate the sedimentation stability of the solution. To determine the retrogradation stability, the viscosities of the solution before and after 24 h of placement at 30 °C were measured and the ratio between the two viscosities calculated.

#### Moisture absorption of starch film

Starch film preserved in relative humidity of 60% for 10 days was weighed, recorded as  $m_2$ . Then the film was dried at 105 °C for 3 h and the weight thereof

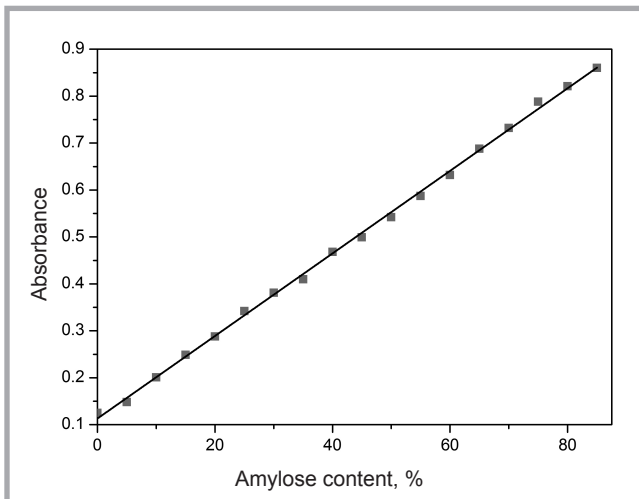

Figure 2. Standard curve of amylose content measurement.

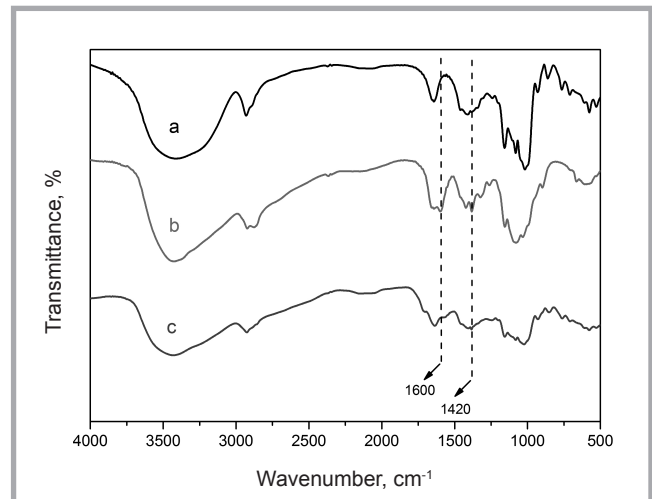

Figure 3. FTIR spectra of (a) pristine starch film, (b) pristine chitosan film, and (c) composite film.

recorded as  $m_1$ . The moisture absorption ( $M\%$ ) of the starch film was determined as follows:

$$M\% = \frac{(m_1 - m_2)}{m_1} \times 100\%$$

#### Scanning electron microscopy analyses

The morphologies of the starch films and glass fiber yarns were observed with a TM-1000 SEM (S440, Leica Cambridge, UK).

#### Energy dispersive spectrometer mapping analyses

Energy dispersive spectrometer mapping (EDS Mapping) was measured on an Oxford IE450X-Max80 EDS (Zeiss Co, Germany). The distribution of elements in the starch films and the surface of glass fiber yarns were observed by EDS Mapping.

#### Determination of stiffness

The sized glass fiber yarn was dried at  $50\text{ }^\circ\text{C}$ , and then it was cut into segments of  $0.5\text{ m}$  from the top of the bobbin inwards. Stiffness measurement of the glass fiber was carried out with the “nail test” method, as described by Feuillade, et al, but with a little revision. The nail was replaced with a stick ( $1\text{ cm}$  in diameter). The test fiber was put on the stick, and the resulting distance  $x$  (cm) between the two extremities of the fiber was measured. The stiffness of glass fiber preserved in different conditions was tested.

#### Measurements of starch film

Measurements of the starch films included the hardness test and adhesion test. The starch film hardness test was per-

formed using a QHQ-A Pencil Scratch Test Instrument (Guangmei Co, China). In accordance with the standard ISO 15184:1998 Paints and varnishes—Determination of film hardness by pencil test, pencils with various grades of hardness were moved over the film surface at an angle of  $45^\circ$  to the horizontal with a force of  $7.5 \pm 0.1\text{ N}$ . The pencils moved on the films were applied from the softest to the hardest in sequence. The pencil hardness was defined by two grades of hardness where the softer one simply produced a writing trace while the harder one left a perceptible scratch on the film’s surface. The hardness of the starch film was defined by the latter’s pencil hardness. The lattice knife test method was used to evaluate the adhesion of modified corn starch to the glass board surface. The starch film’s adhesion was tested with a QFH Film Cross-cut Instrument (Kexing Co, China). A lattice knife was cut into the film surface at a speed of  $50\text{ mm}\cdot\text{s}^{-1}$ . Then the film on the glass board was torn by 3 M tape. In accordance with the standard ISO 2409:1992 Paints and varnishes – Cross-cut test, the film’s adhesion grade was evaluated.

#### Tensile strength measurement

The tensile strength of glass fibers was measured on a H5KS Material Tester (Tinius-Olsen Co, USA) with  $500\text{ mm}$  yarns. Yarns sized with the chitosan-modified corn starch sizing agent were dried at  $100\text{ }^\circ\text{C}$  for  $24\text{ h}$ . Then in the measurement an initial chuck-distance of  $200\text{ mm}$  and drawing speed of  $20\text{ mm}\cdot\text{s}^{-1}$  were adopted. For each sample, five measurements were made and the mean value calculated.

#### Measurements of the combustible-matter content and migration of the sizing agent

The combustible-matter content of the glass fiber was determined in the following steps: A segment of glass fiber ( $100\text{ m}$ ) was picked from the bobbin, and then dried in an oven at  $105\text{ }^\circ\text{C}$  for  $1\text{ h}$  to remove the moisture. Subsequently it was weighed, recorded as  $m_1$ . After weighing, the fiber was heat-treated at  $630\text{ }^\circ\text{C}$  in a furnace for  $0.5\text{ h}$ . The weight of the heat-treated fiber was recorded as  $m_2$ . Then the combustible-matter content (wt.%) was calculated as follows:

$$\text{wt.}\% = \frac{(m_1 - m_2)}{m_1} \times 100\%$$

The combustible-matter content of the outside yarn and inner yarn were recorded as  $\text{wt.}_1$  and  $\text{wt.}_2$ , respectively. The migration ( $M$ ) of the sizing agent was determined as follows:

$$M = \frac{\text{wt.}_1}{\text{wt.}_2}$$

All the tests were repeated at least three times.

## Results and discussion

### Amylose content of corn starch

The starch was a carbohydrate consisting of a large number of glucose units joined by glycosidic bonds. It consisted of two types of molecules: linear and helical amylose and branched amylopectin [21]. Considering that the amylose content of starch may influence the properties of the film formed, we firstly determined the amylose content of the raw starch obtained. A standard curve of the amylose

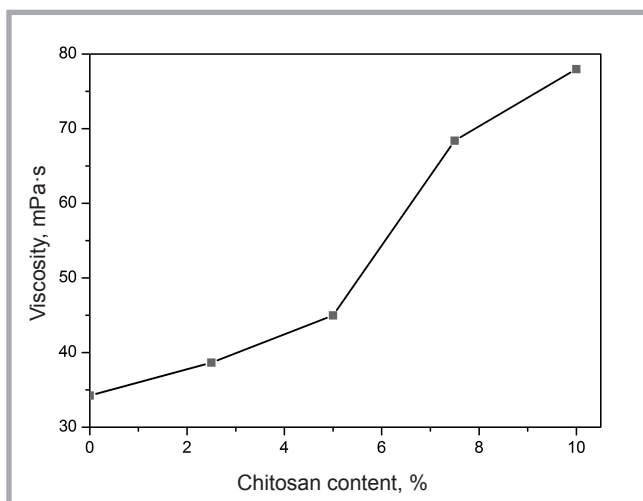

**Figure 4.** Effects of chitosan content on the viscosity of the sizing agent.

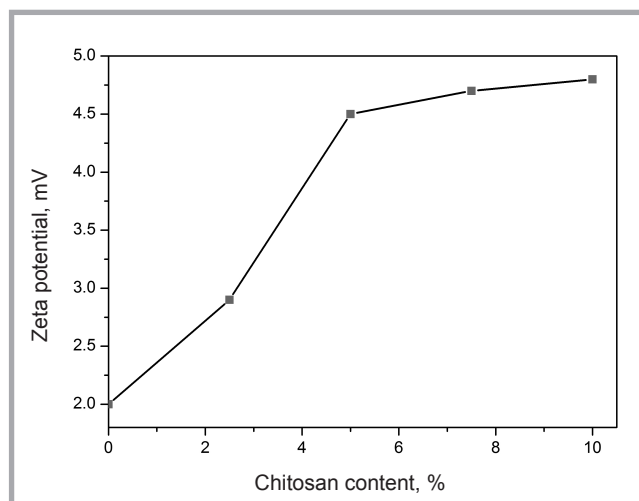

**Figure 5.** Effects of chitosan content on the zeta potential of the sizing agent.

content was drawn, shown in **Figure 2**, and a curve fitting equation was obtained as a result:  $Y = 0.0088X + 0.11285$ . The amylose content of the raw starch could be calculated by bringing its absorbance (0.354) at 720 nm into the equation. The value obtained was 27.41%.

#### Infrared spectrum analysis of starch films

FTIR spectra of corn starch, chitosan, and the modified starch film are shown in **Figure 3**. As illustrated in **Figure 3**, the characteristic absorption peaks of corn starch appeared at 3400, 2900, 1642 and 1080  $\text{cm}^{-1}$ . Characteristic absorption peaks appearing at 3400, 2900, 1600, 1420 and 1080  $\text{cm}^{-1}$  were observed in the spectra of chitosan. Moreover the characteristic stretching vibration peak of C-H and N-H at 3400  $\text{cm}^{-1}$  became wider. However, there was no new peak or characteristic peak in the spectrum of the modified starch comparing with the spectra of the original materials. The conditions above indicated that the procedure of chitosan-modified corn starch was probably physical blending [22]. Although in starch and chitosan there was just physical blending, this does not affect improvement in the properties of the glass fiber.

#### Effect on the viscosity of the modified corn starch sizing agent

Viscosity was an important index of the sizing agent [23, 24]. Influenced by the bond mechanism, the high viscosity sizing agent made the glass fiber acquire a strong adsorption capacity. However, excessively high viscosity was unfavourable

during the drawing and weaving processes [25, 26]. According to previous researches, we acknowledged that the optimum viscosity value of the starch sizing agent ranged from 30 to 50 mPa·s. **Figure 4** reveals the effect of the chitosan content on the viscosity of the modified corn starch sizing agent. The viscosity increased with the increasing content of chitosan, which could result from the emerging of electrostatic repulsion among the charged macromolecules, leading to molecular chain extension. Due to the free rotation of charged molecules, their effective dissolution in the solution increased. Thus in order to find the optimal viscosity, the optimum amount of chitosan content added was 5%, and its corresponding viscosity was 44.99 mPa·s.

#### Effect on the zeta potential of the modified corn starch sizing agent

Owing to the anionic property of the glass surface, the cationic-modified corn starch sizing agent is extensively applied in most enterprises to wet and lubricate glass fiber effectively according to electrostatic adsorption and electronic theory of the bonding mechanism [27]. The effect of chitosan content on the zeta potential of the modified sizing agent is exhibited in **Figure 5**, which reveals that chitosan could greatly improve the cationic properties of the solution. As the only natural cationic polysaccharide, chitosan contains large amounts of  $-\text{NH}_2$ . Therefore in the process of reaction between chitosan and starch,  $-\text{NH}_2$  could easily protonate the form of  $-\text{NH}_3^+$ . Through the change in conformation, the positive charge density of the chitosan surface

increased, and finally the starch was modified through hydrogen bonds [28]. Thus the cationic starch sizing agent was prepared. When the content of chitosan was 5%, the zeta potential of the sizing agent could reach 4.5 mV, which was obviously higher than that in pristine starch (2.0 mV). When the content of chitosan was over 5%, a plateau of zeta potential was observed, which could be attributed to the solubility limit of chitosan in water.

#### Surface tension and contact angle measurement analyses

In the textile production process of glass fiber yarns, a sizing agent with low surface tension can infiltrate and spread on a glass fibre surface effectively [29]. The effect of chitosan content on the surface tension and the contact angle of the modified sizing agent is shown in **Figures 6** and **7**.

As illustrated in **Figure 6**, the surface tension of the modified starch sizing agent decreased to 50  $\text{mN}\cdot\text{m}^{-1}$  when the addition of chitosan increased to 0.6 g, which was far less than the pristine starch, with a value of 64.98  $\text{mN}\cdot\text{m}^{-1}$  in contrast. It could be attributed to the following two reasons: the main chain of chitosan molecules was hydrophobic groups; however,  $-\text{NH}_2$  and  $-\text{OH}$  on the branched chain were hydrophilic groups. On the surface of the solution, hydrophilic groups entered into the water, and at the same time, due to the upward force, the hydrophobic groups rose to the surface of the water. Therefore the dense water molecules on the surface of the sizing agent were broken by the



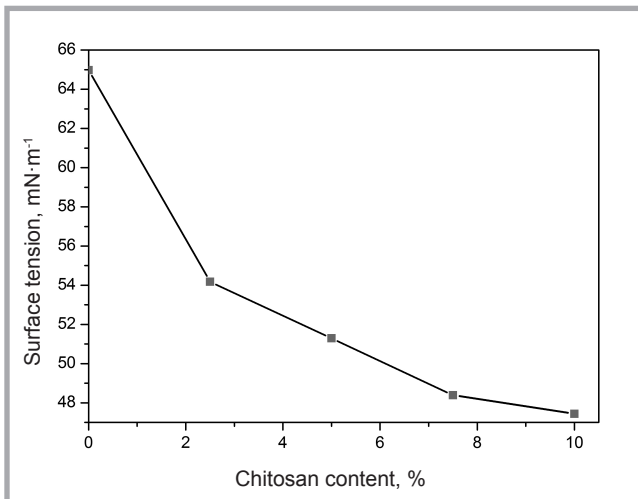

**Figure 6.** Effects of chitosan content on the surface tension of the sizing agent.

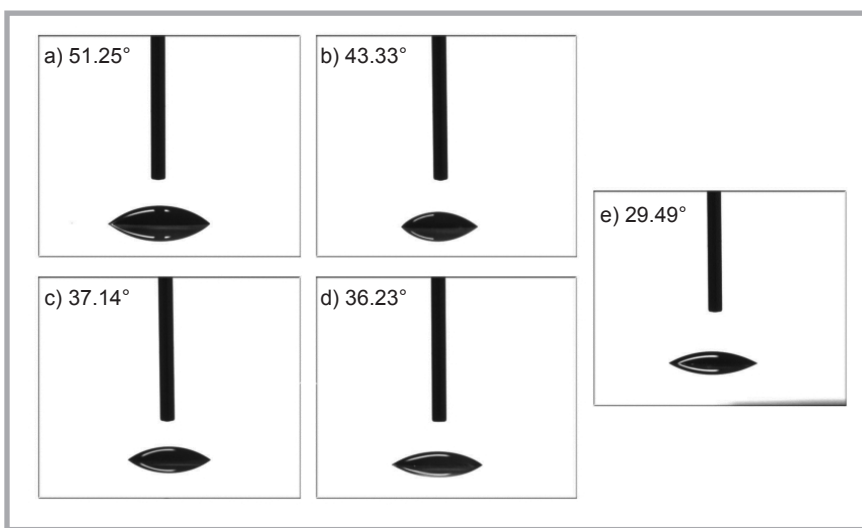

**Figure 7.** Images of contact angles between the sizing agent and glass surface: a) pristine starch, b) 2.5% chitosan, c) 5% chitosan, d) 7.5% chitosan, e) 10% chitosan.

hydrophobic groups. These hydrophobic groups isolated and reduced the interaction between water molecules, resulting in a decrease in surface tension.

As exhibited in **Figure 7**, the chitosan-modified sizing agent could spread on the glass pane more effectively than the pristine starch agent. The contact angle was reduced from 51.25° of the pristine starch to 29.49° of the modified starch, which was consistent with the

trend of the surface tension. Obviously the modified sizing agent had a better wettability to glass materials.

#### Influences of chitosan content on particle size and solution stability

**Table 1** reveals the effect of the chitosan content on the particle size and solution stability of the sizing agent. Obviously the average particle size of the modified starch solution increased significantly in contrast with pristine starch, having no

variation with the increasing of chitosan content. Furthermore the chitosan molecules combined with starch molecules effectively.

Sedimentation stability and retrogradation stability were quantified to indicate the stability of the solution. As illustrated in **Table 1**, the suspensions had excellent sedimentation stability within 12 h. Slight stratification began to emerge when the sizing agents were placed over 12 h. With an increase in the placing time, more serious stratification could be observed. The sedimentation stability of the chitosan modified starch sizing agent was better than that of the pristine starch sizing agent, which could result from the increasing of solution viscosity. Hence the intermolecular force increased, the capability of overcoming gravity enhanced, and the particles could be stably suspended in the solution. In addition, hydrogen bonds between molecules was another crucial factor, beneficial to macromolecules in distributing in water uniformly.

Moreover **Table 1** shows that the retrogradation stability of the modified sizing agent decreased as the chitosan content increased, demonstrating that chitosan could improve the solution stability in the aspect of starch retrogradation. Importantly the amylose molecule was of a straight chain structure while the amylopectin molecular was of a dendritic structure, with retrogradation more likely to occur in amylose than in amylopectin. The chitosan-modified corn starch molecule with a more complex dendritic structure resulted in hydrogen bonds between molecules [30]. In addition, the viscosity of the chitosan modified sizing agent increased, meanwhile the frequency of molecular collision decreased, which could also explain why the retrogradation rate of the modified sizing agent decreased. To sum up, the chitosan-modified sizing agent had better solution stability than the pristine starch agent.

#### Effect on the properties of starch film

The prime function of starch film on the surface of glass fiber yarns was to adhere scattered fibers into a bundle, which could also protect the yarns from mechanical abrasion exerted by machine parts and neighboring ends. In this section, the hardness, adhesive capacity to glass and moisture absorption of the modified starch films were evaluated [31].

**Table 1.** Particle size, solution stability and retrogradation stability of a series of sizing agents.

Chitosan content, wt. %	Particle size, $\mu\text{m}$	Sedimentation stability, %				Retrogradation stability, %
		6 h	12 h	24 h	48 h	
0	35.725	0	0	5.83	12.77	4.67
2.5	39.503	0	0	4.14	10.00	2.42
5	41.154	0	0	2.97	8.35	2.23
7.5	42.285	0	0	1.86	7.42	2.19
10	43.177	0	0	0.88	5.55	2.05

As shown in **Table 2**, the hardness and adhesive capacity to glass of the starch film could be enhanced despite the moisture resistance decreasing with the addition of chitosan, demonstrating that the chitosan could make up for some of the pitfalls of starch film effectively.

The hardness of chitosan-modified corn starch film was better than for the pristine corn starch film. What should be emphasized is that chitosan molecules could fill the gap between pristine starch macromolecules because of the emerging of hydrogen bonds between chitosan and starch molecules in the process of film forming, which made the modified film more compact. Thus the hardness of the modified film became better.

Furthermore the variation trend of film adhesion was similar to film hardness. The cationic-chitosan-modified starch contained numerous  $-NH_2$  and  $-OH$  groups. Its adhesion ability to a glass board surface was much better than for pristine corn starch film, which could be attributed to the interaction mechanism of electrostatic adherence and the bonding effect [32].

Moisture absorption results of the starch films are exhibited in **Table 2**, which revealed that the moisture absorption of the chitosan modified corn starch film was higher than that of the pristine corn starch film. Although the modified film was more compact, considerable hydrophilic groups in its structure could be the reason for a poorer moisture resistance [33].

### Film photograph

**Figure 8** demonstrates digital images of the films formed by pristine starch and modified starch on glass. Cracks and holes were clearly observed in the film of pristine starch film. Contrary to the phenomenon that the film formed by the modified starch was smooth and dense, the pristine starch film had a poor adhesion ability with respect to glass. The modified starch had much better adhesion ability to glass.

### SEM and EDS mapping analyses of starch films and fibers

SEM images of the films are shown in **Figure 9**. In the film formed by pristine starch (**Figure 9a**), some scattered pores were observed, which could be attributed to the molecule entanglement and reunion during water evaporation [34]. In contrast, a more compact and dense

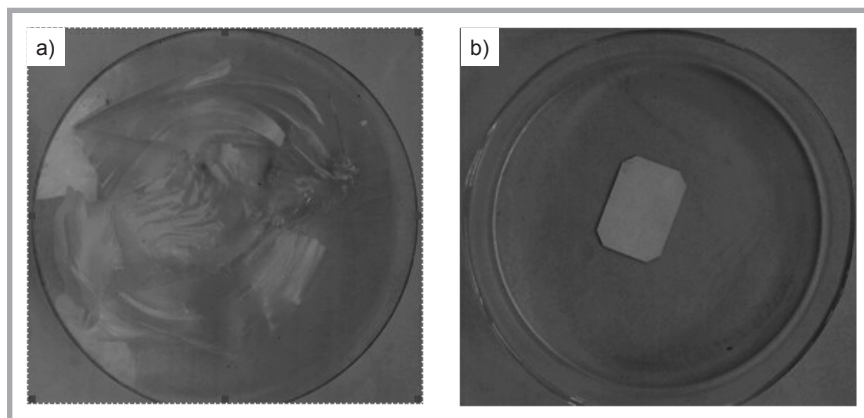

**Figure 8.** Photographs of pristine starch film a) and chitosan modified starch film b).

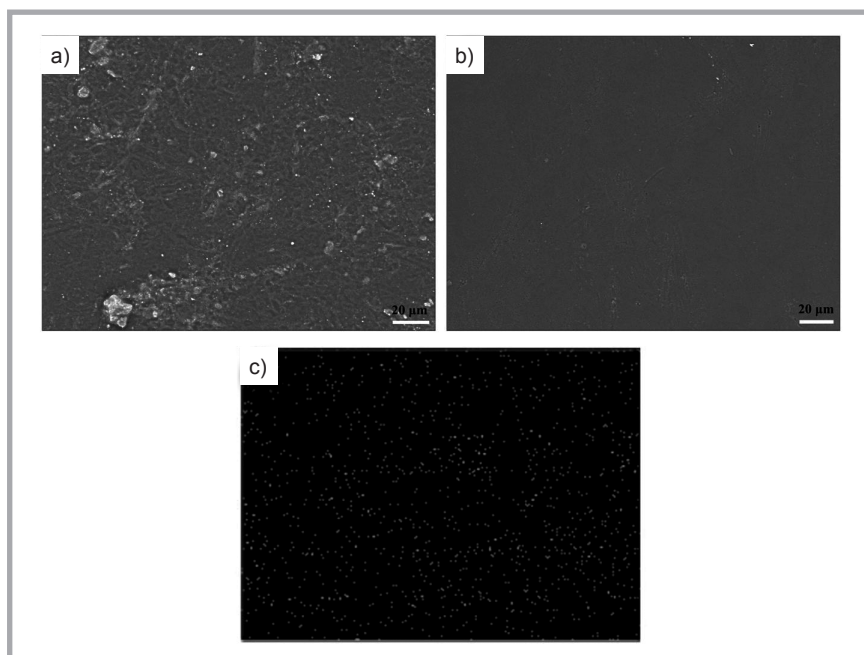

**Figure 9.** SEM images of films and the elemental distribution of N on the film surface: a) film formed by pristine starch, b) film formed by chitosan modified starch, c) the elemental distribution of N on the film surface.

film could be obtained when chitosan was added (**Figure 9b**). **Figure 9c** reveals that the distribution of the nitrogen element in the starch film was uniform. Due to the fact that starch itself does not contain a nitrogen element, these nitrogens must come from chitosan. The result demonstrated a good compatibility between starch and chitosan.

**Figure 10** exhibits SEM images of glass fiber yarns. As shown in **Figure 10.a**, glass fibers without sizing were messy and had numerous breakages. **Figures 10.b** and **10.c** present SEM images of yarns sized by the pristine corn starch sizing agent and modified sizing agent, respectively. The pristine corn starch sizing agent spread on the modified film sur-

**Table 2.** Hardness, adhesion and adsorption rate of a series of membranes.

Chitosan content, wt. %	Hardness	Adhesion	Moisture absorption, %
0	1H	2	44.35
2.5	3H	1	58.35
5	4H	0	66.34
7.5	4H	0	79.60
10	4H	0	85.88

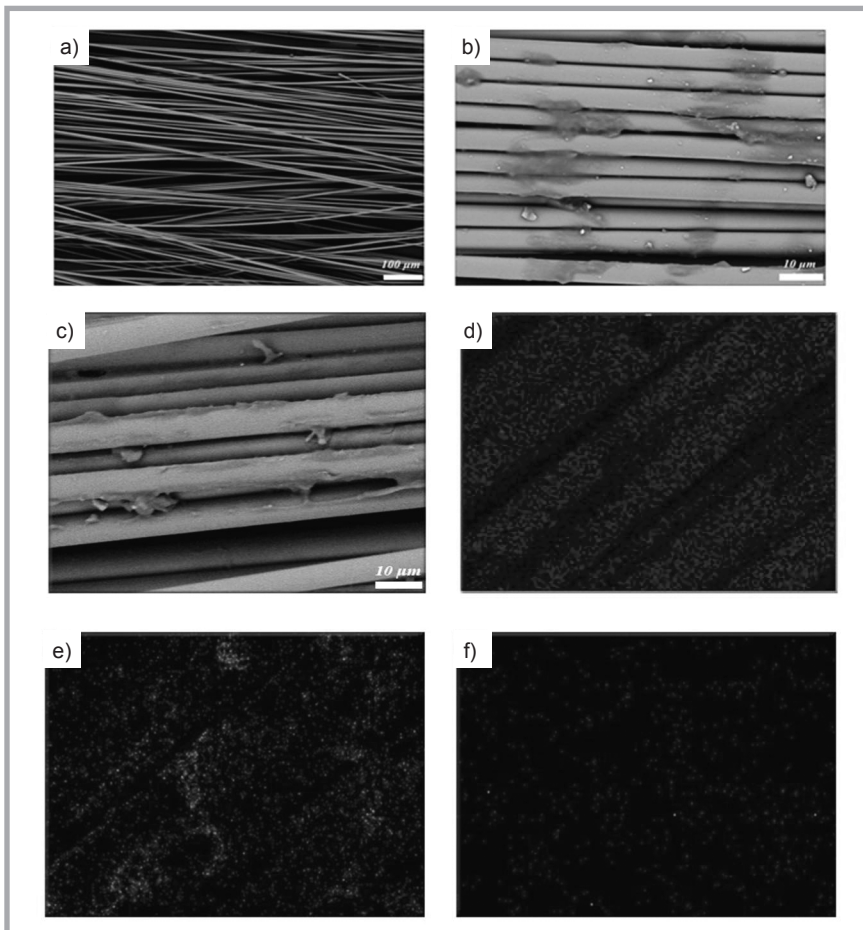

**Figure 10.** SEM images of fibers and the elemental distribution on the fiber surface: a) pristine glass fibers, b) glass fibers sized by the pristine corn starch sizing agent, c) glass fibers sized by the modified sizing agent, d) the elemental distribution of Si, e) the elemental distribution of C, f) the elemental distribution of N.

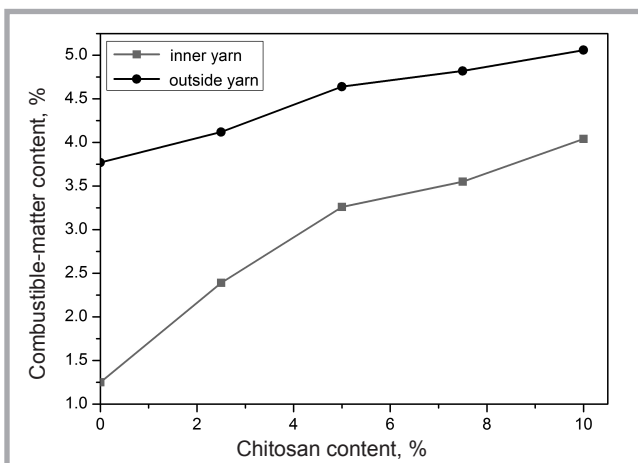

**Figure 11.** Effects of chitosan content on the combustible-matter content of glass fiber yarns.

**Table 3.** Migration, stiffness and tensile strength of a series of glass fibers.

Chitosan content, wt. %	Migration	Stiffness, cm	Tenacity, N/tex
0	3.01	3.25	0.28
2.5	1.72	4.46	0.38
5	1.42	4.96	0.43
7.5	1.35	5.03	0.44
10	1.25	5.17	0.45
pristine glass fibers	–	2.80	0.21
paraffin glass fibers	–	5.11	0.42

face unevenly, which had relatively poor adhesion to glass fiber. In contrast, the modified sizing agent had better adhesion and bundling properties (**Figure 10.c**). **Figure 10** shows the distribution of silicon (**d**), carbon (**e**) and nitrogen (**f**) elements on the glass fiber yarn surface, which suggested that the chitosan-modified corn starch sizing agent could spread on the glass fiber yarn surface uniformly.

#### Effect on the combustible-matter content of glass fiber yarns

**Figure 11** reveals the effects of the chitosan content on the combustible-matter content of glass fiber yarns, which indicates the content of the sizing agent over glass fiber yarns [35]. The combustible-matter content increased with an increase in the chitosan content, which could result in a combining effect for viscosity and the zeta potential. Affected by the bonding mechanism, the viscosity of the modified sizing agent increased, and the modified sizing agent could adhere to the surface of the yarns more easily. Furthermore the glass surface was anionic. According to electrostatic adsorption and electronic theory, the cationic-modified sizing agent could attach to the glass fiber more effectively [36]. As shown in **Figure 11**, the combustible-matter content was higher in the outside yarn on the bobbin than that of the inner one, which could be attributed to the migration of the sizing agent with water evaporation during the drying process. Moreover the migration was relieved with the increasing of chitosan.

#### Effect on the properties of glass fiber yarns

The effects of chitosan content on the migration of the sizing agent, tensile strength and stiffness of glass fiber yarns are displayed in **Table 3**. The migration of the sizing agent was another significant index to evaluate the performance of the sizing agent [37]. In the process of yarn traction, the sizing agent migrated towards the exterior of the roller as a result of the centripetal force [38, 39]. In addition, the organic particles in the sizing agent migrated outward as the water evaporated in the yarns during the drying process, which led to the fact that the outside yarn on the bobbin usually had a higher combustible-matter content than the inner one. As presented in **Table 3**, the migration performance of yarns sized with a modified sizing agent was better than for those sized with a pristine starch



sizing agent, which was due to an increase in the bonding force between the cationic starch and glass fibers surface. As a result, in the course of infiltration and drying, the chitosan-modified sizing agent could not migrate easily.

The results above revealed the fact that the modified sizing agent with 5% chitosan content could not only obtain stable viscosity and a strong adhesion property with respect to glass fibers, but it also forms a tough and abrasion-resistant film to protect the yarns. Further addition of chitosan did not have a significant effect on improving the performance. Moreover the mechanical properties of the yarns were consistent with the previous prediction. As illustrated in **Table 3**, the tensile strength and stiffness of the yarns sized with the modified sizing agent were higher than those sized with the pristine starch sizing agent. When the content of chitosan was 0.6 g, the yarn's tensile strength was 0.43 N·tex<sup>-1</sup> and the stiffness 4.96 cm. These mechanical properties were superior to those of paraffin glass fiber yarns [40]. The observation suggested that the combination of cationic starch and glass fibers was tighter, and that modified starch molecules were bonded to the glass fiber surface more firmly. However, the mechanical performance did not change significantly when more than 5% of chitosan was added.

## Conclusions

Comparing the performance of native-starch sized and chitosan-modified-starch sized yarns, the modification of starch with chitosan was an effective method to improve the properties of the starch-based sizing agent. When 5% of chitosan was added, the overall performance of the modified sizing agent was optimal. Chitosan could reduce the surface tension and increase the Zeta potential of the starch. The modified sizing agent could splice and spread on the surface of glass fiber effectively. In addition, the solution stability of the modified sizing agent was optimised. The film formed by the modified starch was denser than that of the pristine starch film, which could protect the glass fiber yarns from mechanical abrasion exerted by machine parts and neighboring ends more effectively. The modification increased the adhesion of starch to glass fiber and enhanced the mechanical properties of the yarns. The tensile strength reached

0.43 N·tex<sup>-1</sup> and the stiffness 4.96 cm, which were superior to those of paraffin-sized yarns.

## Acknowledgement

This work was financially supported by the project: National High Technology Research and Development Program of 863 Project (Approval number: 2009 aa035002), China.

## References

- Ivashchenko EA. Sizing and Finishing Agents for Basalt and Glass Fibers. *Theoretical Foundations of Chemical Engineering* 2009; 43: 511-516.
- Thomason JL, and Adzima LJ. Sizing up the interphase: an insider's guide to the science of sizing. *Composites Part A: Applied Science and Manufacturing* 2001; 32: 313-321.
- Zhang RL, Zhang JS, Zhao LH, and Sun YL. Sizing Agent on the Carbon Fibers Surface and Interface Properties of Its Composites. *Fibers and Polymers* 2015; 16: 657-663.
- Zhu ZF, Xu DS, Guo JS, and Xia DC. Comparative Study on Sizing Properties of Amphoteric Starch and Phosphorylated Starch for Warp Sizing. *Fibers and Polymers* 2012; 13: 177-184.
- Marston C, Gabbitas B, and Adams J. The effect of fibre sizing on fibres and bundle strength in hybrid glass carbon fibre composites. *Journal of Materials Science* 1997; 32: 1415-1423.
- Merhi D, Michaud V, Comte E, Manson JE. Predicting sizing dependent bending rigidity of glass fibre bundles in sheet moulding compounds. *Composites Part A: Applied Science and Manufacturing* 2006; 37: 1773-1786.
- Sellitti C, Vargiu S, Martuscelli E, and Fabbro D. Wettability of glass fibres with different sizings and their adhesion to unsaturated polyester matrices. *Journal of Materials Science* 1987; 22: 3477-3484.
- McMican R. Sizing stability is a key element for glass fibre manufacturing. *Reinforced Plastics* 2012; 56: 29-32.
- Kaur B, Ariffin F, Bhat R, A. Karim A. Progress in starch modification in the last decade. *Food Hydrocolloids* 2012; 26: 398-404.
- Moad G. Chemical modification of starch by reactive extrusion. *Progress in Polymer Science* 2011; 36: 218-237.
- Jobling S. Improving starch for food and industrial applications 2004.
- Marc J.E.C. van der Maarel, Bart van der Veen, Joost C.M. Uitdehaag, Hans Leemhuis, L. Dijkhuizen. Properties and applications of starch-converting enzymes of the  $\alpha$ -amylase family. *Journal of Biotechnology* 2002; 94:137-155.

- Li ML, Jin EQ, Qiao ZY, and Mao DD. Effects of Graft Modification on the Properties of Chitosan for Warp Sizing. *Fibers and Polymers* 2015; 16: 1098-1105.
- Ferrero F, Periolatto M, Burelli S, and Carletto RA. Silk Grafting with Chitosan and Crosslinking Agents. *Fibers and Polymers* 2010; 11: 185-192.
- Ashori A, Raverty WD, and Harun J. Effect of Chitosan Addition on the Surface Properties of Kenaf (*Hibiscus cannabinus*) Paper. *Fibers and Polymers* 2005; 6: 174-179.
- Bourtoom T, and Chinnan MS. Preparation and properties of rice starch-chitosan blend biodegradable film. *LWT-Food Science and Technology* 2008; 41: 1633-1641.
- Thomason JL, and Dwight DW. The use of XPS for characterisation of glass fibre coatings. *Composites Part A: Applied Science and Manufacturing* 1999; 30: 1401-1413.
- Zhu ZF, Wang M, and Li W. Starch Maleation and Sulfosuccinylation to Alleviate the Intrinsic Drawback of Brittleness of Cornstarch Film for Warp Sizing. *Fibers and Polymers* 2015; 16: 1890-1897.
- Feng XY, Zheng K, Wang CP, Chu FX, and Chen Y. Durable Antibacterial Cotton Fabrics with Chitosan Based Quaternary Ammonium Salt. *Fibers and Polymers* 2016; 17: 371-379.
- Wang Y, Li H, Wang XD, Lei H and Huo JC. Chemical modification of starch with epoxy resin to enhance the interfacial adhesion of epoxy-based glass fiber composites. *RSC Advances* 2016; 6: 84187-84193.
- Farayde MF, Daryne C, Fábio Y, Silvia MM, Rodolfo CJ, Katlen A, Fernanda PC, and Lucia HI. Comparative study of processing methods for starch/gelatin films. *Carbohydrate Polymers* 2013; 95: 681-689.
- Tuhin MO, Rahman N, Haque ME, Khan RA, Dafader NC, Islam R, Nurnabi M, and Tonny W. Modification of mechanical and thermal property of chitosan-starch blend films. *Radiation Physics and Chemistry* 2012; 81: 1659-1668.
- Zhu ZF, Zhou YS, and Li JF. Environment-Friendly Crosslinking of Cornstarch by Pentanedioic Acid for Stabilizing the Viscosity of Starch Paste during Warp Sizing. *Fibers and Polymers* 2014; 15: 707-715.
- Yasuo Iida, Toru Tuziuti, Kyuichi Yasui, Atsuya Towata, Teruyuki Kozuka. Control of viscosity in starch and polysaccharide solutions with ultrasound after gelatinization. *Innovative Food Science and Emerging Technologies* 2008; 9: 140-146.
- A. Izaguirre, J. Lanás, J.I. Álvarez. Behaviour of a starch as a viscosity modifier for aerial lime-based mortars. *Carbohydrate Polymers* 2010; 80: 222-228.
- Wu DX, Shu QY, Wang ZH, Xia YW. Effect of gamma irradiation on starch viscosity and physicochemical properties of different rice. *Radiation Physics and Chemistry* 2002; 65: 79-86.



27. Wongsagonsup R, Shobsngob S, Oonkhanond B, Varavinit S. Zeta Potential ( $\zeta$ ) and Pasting Properties of Phosphorylated or Crosslinked Rice Starches. *Starch/Stärke* 2005; 57: 32-37.
28. Shukur MF, Ithnin R, and Kadir MFZ. Electrical properties of proton conducting solid biopolymer electrolytes based on starch–chitosan blend. *Ionics* 2014; 20: 977-999.
29. Lundqvist H, Eliasson AC, Olofsson G. Binding of hexadecyltrimethylammonium bromide to starch polysaccharides. Part I. Surface tension measurements. *Carbohydrate Polymers* 2002; 49:109-120.
30. Zhong Y, Song XY, and Li YF. Antimicrobial, physical and mechanical properties of kudzu starch–chitosan composite films as a function of acid solvent types. *Carbohydrate Polymers* 2011; 84: 335-342.
31. Zhang CH, Xu DS, and Zhu ZF. Octenylsuccinylation of Comstarch to Improve Its Sizing Properties for Polyester/Cotton Blend Spun Yarns. *Fibers and Polymers* 2014; 15: 2319-2328.
32. Xu YX, Kim KM, Hanna MA, and Nag D. Chitosan–starch composite film: preparation and characterization. *Industrial Crops and Products* 2005; 21: 185-192.
33. Chillo S, Flores S, Mastromatteo M, Conte A, Gerschenson L, and Del Nobile MA. Influence of glycerol and chitosan on tapioca starch-based edible film properties. *Journal of Food Engineering* 2008; 88: 159-168.
34. Dang KM, and Yoksan R. Development of thermoplastic starch blown film by incorporating plasticized chitosan. *Carbohydrate Polymers* 2015; 115: 575-581.
35. Shim WS, Lee H, and Lee DW. The Interaction of Moving Yarns with Stationary Surfaces. *Fibers and Polymers* 2013; 14: 164-171.
36. Tanoglu M, Ziaee S, Mcknight SH, Palmese GR, and JR Gillespie JW. Investigation of properties of fiber/matrix interphase formed due to the glass fiber sizings. *Journal of Materials Science* 2001; 36: 3041-3053.
37. Zinck P, Mäder E, and Gerard J. Role of silane coupling agent and polymeric film former for tailoring glass fiber sizings from tensile strength measurements. *Journal of Materials Science* 2001; 36: 5245-5252.
38. Cho DH and Jeong Y. Study on the Strength Retention of Technical Cord Yarn. *Fibers and Polymers* 2006; 7: 305-309.
39. Koo YS. Correlation of Yarn Tension with Parameters in the Knitting Process. *Fibers and Polymers* 2002; 3: 80-84.
40. Feih S, Thraner A, and Lilhol H. Tensile strength and fracture surface characterization of sized and unsized glass fibers. *Journal of Materials Science* 2005; 40: 1615-1623.

Received 26.04.2016 Reviewed 16.10.2016



## INSTITUTE OF BIOPOLYMERS AND CHEMICAL FIBRES

### LABORATORY OF ENVIRONMENTAL PROTECTION

The Laboratory works and specialises in three fundamental fields:

■ **R&D activities:**

- research works on new technology and techniques, particularly environmental protection;
- evaluation and improvement of technology used in domestic mills;
- development of new research and analytical methods;

■ **research services** (measurements and analytical tests) in the field of environmental protection, especially monitoring the emission of pollutants;

■ **seminar and training activity** concerning methods of instrumental analysis, especially the analysis of water and wastewater, chemicals used in paper production, and environmental protection in the paper-making industry.

**Since 2004 Laboratory has had the accreditation of the Polish Centre for Accreditation No. AB 551, confirming that the Laboratory meets the requirements of Standard PN-EN ISO/IEC 17025:2005.**



**Investigations in the field of environmental protection technology:**

- Research and development of waste water treatment technology, the treatment technology and abatement of gaseous emissions, and the utilisation and reuse of solid waste,
- Monitoring the technological progress of environmentally friendly technology in paper-making and the best available techniques (BAT),
- Working out and adapting analytical methods for testing the content of pollutants and trace concentrations of toxic compounds in waste water, gaseous emissions, solid waste and products of the paper-making industry,
- Monitoring ecological legislation at a domestic and world level, particularly in the European Union.

**A list of the analyses most frequently carried out:**

- Global water & waste water pollution factors: COD, BOD, TOC, suspended solid (TSS), tot-N, tot-P
- Halogenoorganic compounds (AOX, TOX, TX, EOX, POX)
- Organic sulphur compounds (AOS, TS)
- Resin and chlororesin acids
- Saturated and unsaturated fatty acids
- Phenol and phenolic compounds (guaiacols, catechols, vanillin, veratrols)
- Tetrachlorophenol, Pentachlorophenol (PCP)
- Hexachlorocyclohexane (lindane)
- Aromatic and polyaromatic hydrocarbons
- Benzene, Hexachlorobenzene
- Phthalates
- Carbohydrates
- Glycols
- Polychloro-Biphenyls (PCB)
- Glyoxal
- Tin organic compounds

**Contact:**

INSTITUTE OF BIOPOLYMERS AND CHEMICAL FIBRES  
ul. M. Skłodowskiej-Curie 19/27, 90-570 Łódź, Poland  
Michał Janiga, M.Sc., Eng.  
m.janiga@ibwch.lodz.pl icpnls@ibwch.lodz.pl